



# WorkCentre 5845/5855/5865/5875/5890 ConnectKey 1.5 Information Assurance Disclosure Paper Version 1\_2

Prepared by:

Ralph H. Stoos Jr.  
Xerox Corporation  
800 Phillips Road  
Webster, New York 14580

©2012, 2013, 2014, 2015 Xerox Corporation. All rights reserved. Xerox and the sphere of connectivity design are trademarks of Xerox Corporation in the United States and/or other countries.

Other company trademarks are also acknowledged.

Document Version: 1.1 (August 2013).





Contributors:

Michael Barrett  
Steve Beers  
Bob Crumrine  
Mike Faraoni  
Gordon Farquhar  
Mirelsa Fontanes  
Tim Hunter  
Larry Kovnat  
Tom Pierce  
Roger Rhodes  
Steve Sydorowicz  
R. Ben Wilkie  
Bob Zolla  
Ralph H. Stoos Jr.



<b>1. INTRODUCTION .....</b>	<b>6</b>
1.1. Purpose .....	6
1.2. Target Audience .....	6
1.3. Disclaimer .....	6
<b>2. DEVICE DESCRIPTION.....</b>	<b>7</b>
2.1. Security-relevant Subsystems .....	8
2.1.1. Physical Partitioning .....	8
2.1.2. Security Functions allocated to Subsystems .....	9
2.2. Controller .....	9
2.2.1. Purpose .....	9
2.2.2. Memory Components .....	10
2.2.3. External Connections .....	12
2.2.4. USB Ports .....	13
2.3. Fax Module.....	14
2.3.1. Purpose .....	14
2.3.2. Hardware .....	14
2.4. Scanner .....	15
2.4.1. Purpose .....	15
2.4.2. Hardware .....	15
2.5. Graphical User Interface (GUI) .....	15
2.5.1. Purpose .....	15
2.6. Marking Engine (Image Output Terminal or IOT) .....	15
2.6.1. Purpose .....	15
2.6.2. Hardware .....	15
2.7. System Software Structure .....	16
2.7.1. Open-source components .....	16
2.7.2. Operating System Layer in the Controller .....	17
2.7.3. Network Protocols .....	18
2.8. Logical Access.....	19
2.8.1. Network Protocols .....	19
2.8.2. Ports .....	20
2.8.3. IP Filtering .....	26
<b>3. SYSTEM ACCESS.....</b>	<b>27</b>
3.1. Authentication Model .....	27
3.2. Login and Authentication Methods.....	29
3.2.1. System Administrator Login [All product configurations] .....	29
3.2.2. User authentication.....	29



<b>3.3.</b>	<b>System Accounts</b> .....	<b>34</b>
3.3.1.	Printing.....	34
3.3.2.	Network Scanning .....	34
<b>4.</b>	<b>SECURITY ASPECTS OF SELECTED FEATURES</b> .....	<b>35</b>
<b>4.1.</b>	<b>McAfee Enhanced Security / Integrity Control</b> .....	<b>35</b>
4.1.1	Enhanced Security.....	35
4.1.2	Integrity Control (Optional Feature) .....	35
4.1.3	ePolicy Orchestrator .....	35
<b>4.2.</b>	<b>Audit Log</b> .....	<b>36</b>
<b>4.3.</b>	<b>Xerox Standard Accounting</b> .....	<b>45</b>
<b>4.4.</b>	<b>User Permissions Role Based Access Control (RBAC)</b> .....	<b>46</b>
<b>4.5.</b>	<b>SMart eSolutions</b> .....	<b>47</b>
<b>4.6.</b>	<b>Encrypted Partitions</b> .....	<b>47</b>
<b>4.7.</b>	<b>Image Overwrite</b> .....	<b>48</b>
4.7.1.	Algorithm .....	48
4.7.2.	User Behavior .....	48
4.7.3.	Overwrite Timing .....	49
4.7.4.	Overwrite Completion Reporting.....	49
	<b>Remote Scanning Procedure and Security Issue</b> .....	<b>50</b>
	To enable the Workflow Scanning Remote Start (TWAIN) feature: .....	50
	<b>NOTE: The user needs to be aware that when remote scan is enabled there is a blocking screen from when they put a document in the Document Feeder or on the Document Glass to when they initiate their job, that prohibit a second user could initiate a remote scan. The second user could receive the first user's job. This presents a security issue.</b> .....	<b>50</b>
	Multifunction Devices Supporting Remote Scanning (as of this writing).....	50
<b>4.8.</b>	<b>FIPS</b> .....	<b>51</b>
4.8.1.	FIPS 140-2 Compliance.....	51
4.8.2.	Enabling FIPS 140 Mode .....	52
<b>4.9.</b>	<b>Email Signing and Encryption to Self</b> .....	<b>52</b>
<b>4.10.</b>	<b>Software Self Test</b> .....	<b>52</b>
<b>5.1.</b>	<b>Responses to Known Vulnerabilities</b> .....	<b>53</b>
5.1.1.	Security @ Xerox ( <a href="http://www.xerox.com/security">www.xerox.com/security</a> ) .....	53
	<b>APPENDICES</b> .....	<b>54</b>
	<b>Appendix A – Abbreviations</b> .....	<b>54</b>
	<b>Appendix B – Supported MIB Objects</b> .....	<b>56</b>
	<b>Appendix C –Standards</b> .....	<b>59</b>
	<b>Appendix E – References</b> .....	<b>61</b>





# 1. Introduction

The WorkCentre 7220-7225 multifunction systems are among the latest versions of Xerox copier and multifunction devices for the general office.

## 1.1. Purpose

The purpose of this document is to disclose information for the WorkCentre products with respect to device security. Device Security, for this paper, is defined as how image data is stored and transmitted, how the product behaves in a networked environment, and how the product may be accessed, both locally and remotely. Please note that the customer is responsible for the security of their network and the WorkCentre products do not establish security for any network environment.

The purpose of this document is to inform Xerox customers of the design, functions, and features of the WorkCentre products relative to Information Assurance (IA).

This document does NOT provide tutorial level information about security, connectivity, PDLs, or WorkCentre products features and functions. This information is readily available elsewhere. We assume that the reader has a working knowledge of these types of topics. However, a number of references are included in the Appendix.

## 1.2. Target Audience

The target audience for this document is Xerox field personnel and customers concerned with IT security.

## 1.3. Disclaimer

The information in this document is accurate to the best knowledge of the authors, and is provided without warranty of any kind. In no event shall Xerox Corporation be liable for any damages whatsoever resulting from user's use or disregard of the information provided in this document including direct, indirect, incidental, consequential, loss of business profits or special damages, even if Xerox Corporation has been advised of the possibility of such damages

## 2. Device Description

This product consists of an in put document handler and scanner, marking engine including paper path, controller, and user interface.



Figure 2-1 WorkCentre 5845/5855/5865/5875/5890 Multifunction System

## 2.1. Security-relevant Subsystems

### 2.1.1. Physical Partitioning

The security-relevant subsystems of the product are partitioned as shown in Figure 2-2.

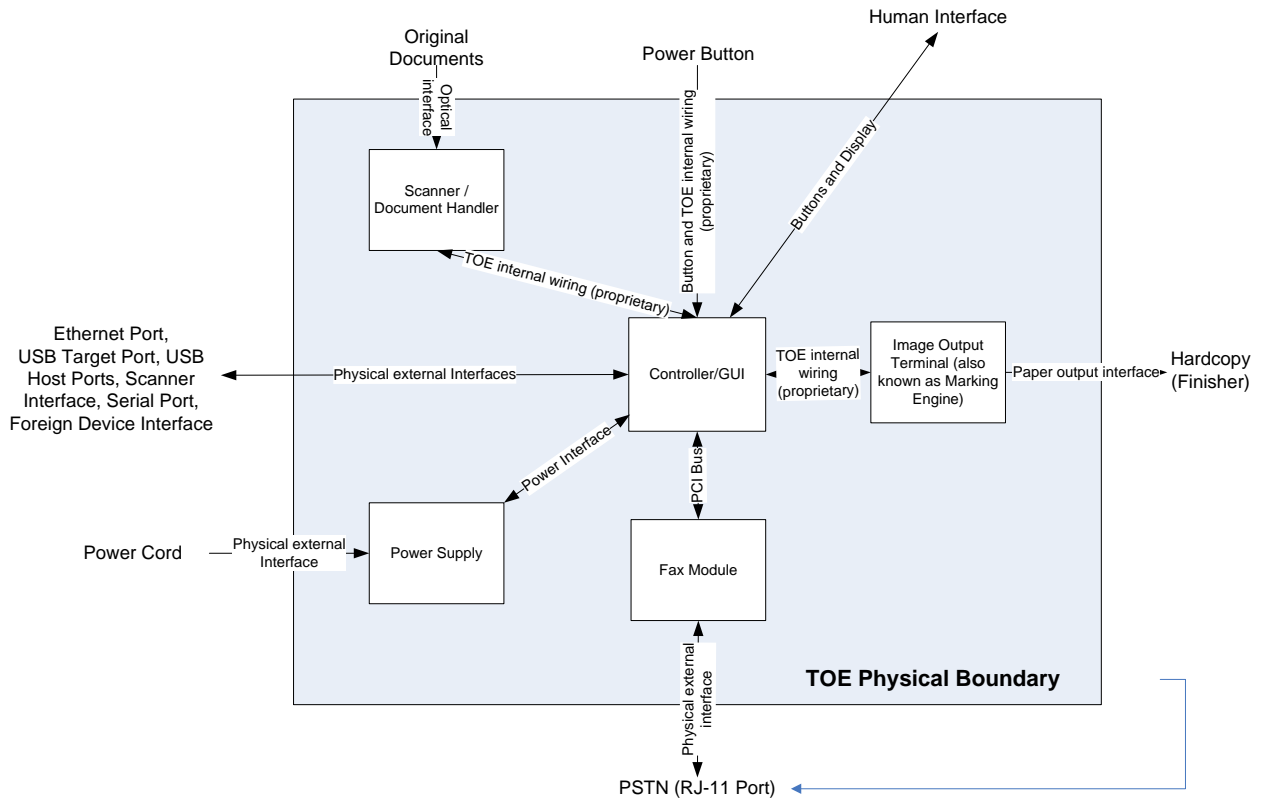

Figure 2-2 System functional block diagram



## 2.1.2. Security Functions allocated to Subsystems

Security Function	Subsystem
Image Overwrite	Controller Graphical User Interface
System Authentication	Controller Graphical User Interface
Network Authentication	Controller Graphical User Interface
Security Audit	Controller
Cryptographic Operations	Controller
User Data Protection – SSL	Controller
User Data Protection – IP Filtering	Controller
User Data Protection – IPSec	Controller
User Data Protection – Disk Encryption	Controller
Network Management Security	Controller
Fax Flow Security	Fax Module Controller Graphical User Interface
Security Management	Controller Graphical User Interface

**Table 1 Security Functions allocated to Subsystems**

## 2.2. Controller

### 2.2.1. Purpose

The controller provides both network and direct-connect external interfaces, and enables copy, print, email, network scan, server fax, internet FAX, and LanFAX functionality. Network scanning, server fax, internet fax, and LanFax, are standard features. Image Overwrite, which is included as a standard feature, enables both Immediate and On-Demand overwrite of any temporary image data created on disk. The controller also incorporates an open-source web server (Apache) that exports a Web User Interface (WebUI) through which users can submit jobs and check job and machine status, and through which system administrators can remotely administer the machine.

The controller contains the image path, which uses proprietary hardware and algorithms to process the scanned images into high-quality reproductions. Scanned images may be temporarily buffered in DRAM to enable electronic pre-collation, sometimes referred to as scan-once/print-many. When producing multiple copies of a document, the scanned image is processed and buffered in the DRAM in a proprietary format. Extended buffer space for very large documents is provided on the network disk. The buffered bitmaps are then read from DRAM and sent to the Image Output Terminal (IOT) for marking on hardcopy output. For long documents, the production of hardcopy may begin before the entire original is scanned, achieving a level of concurrency between the scan and mark operations.

The controller operating system is Wind River Linux, kernel v. 2.6.34+. (Note: Consistent with Flaw Remediation, this baseline may be updated as indicated by the '+' sign. Unnecessary services such as rsh, telnet and finger are disabled in the Operating System. FTP is used in client-only mode by the network scanning feature for the filing of scanned images and the retrieval of Scan Templates; however the controller does not contain an FTP server.

The controller works with the Graphical User Interface (GUI) assembly to provide system configuration functions. A System Administrator PIN must be entered at the GUI in order to access these functions.

## 2.2.2. Memory Components

Volatile Memory Description				
Type (SRAM, DRAM, etc)	Size	User Modifiable (Y/N)	Function or Use	Process to Clear:
DDR3 SDRAM non ECC – System Memory	2GB	N	Executable code, Printer control data, temporary storage of job data	Power Off System
DDR2 SDRAM non ECC – Image Memory	512MB	N	Image data - copy/scan/print/Fax	Power Off System
DDR2 SDRAM non ECC – Page Buffer	512MB	N	Scan image page buffer	Power Off System
SRAM	1MB	N	JPEG image processing buffer	Power Off System
<p><b>Additional Information:</b>            There are two main blocks of Volatile memory in the controller, System and Image memory. System memory contains a mixture of executable code, control data and job data. Job data exists in System memory while the job is being processed. Once the job is complete the memory is reused for the next job. Likewise Image memory holds job data in a proprietary format while the job is being processed. Once the job is complete the image memory is reused for subsequent jobs.</p>				
Non-Volatile Memory Description				
Type (Flash, EEPROM, etc)	Size	User Modifiable (Y/N)	Function or Use	Process to Clear:
SD CARD	4GB	via Diagnostics	Control set points, configuration settings, Boot Memory	Diagnostic
EEPROM	1Mb	Via Diagnostics	Programs Taurus ASIC	Diagnostic
Flash	38KB	Via Diagnostic	Boot sector for power manager, MAC address	Diagnostic
Battery Backed SRAM	6kB	Via Diagnostic	Power manager variables	Diagnostic
EEPROM	1Mb	Via Diagnostics	Programs Taurus ASIC	Diagnostic
<p><b>Additional Information:</b>            All memory listed above contains code for execution and configuration information. No user or job data is stored in these locations.</p>				

**Table 2 Controller volatile and non-volatile memory components**



<b>Hard Disk Descriptions</b>					
<b>Complete this table if the device has media storage capability</b>					
<b>Drive / Partition (System, Image):</b>	<b>Removable Y / N</b>	<b>Size:</b>	<b>User Modifiable: Y / N</b>	<b>Function:</b>	<b>Process to Clear:</b>
System Disk / System partition	No	27GB	N with normal operation	Operating System, Fonts, configuration file storage.	Diagnostic Procedure
System Disk / Image partition	No	48GB	N with normal operation	Job Images	Diagnostic Procedure
<p><b>Additional Information:</b>                      This System disk contains the Linux Operating System and stores executables, fonts, and settings files. During normal operation, job files do not remain stored on this disk. One exception is "Print From", "Saved Jobs" feature. Customer jobs saved on the machine's hard disk using this feature must be manually deleted by the customer. If On Demand Overwrite and full is selected all saved jobs will be erased.                      The Image partition stores images in a proprietary encoded format in non-contiguous blocks. Customer image data is only stored to the image partition if EPC memory is full. User data and image data may be completely erased with a full Overwrite using a three-pass algorithm which conforms to U.S. Department of Defense Directive 5220.22-M, the entire image disk partition is erased and checked.</p>					

**Table 3 Hard Disk Drive**

<b>RFID Devices</b>	
<b>RFID Device and location</b>	<b>Purpose</b>
N/A	No RFID Devices are contained in the device
<p><b>Additional Information:</b></p>	

### 2.2.3. External Connections

The controller printed wiring boards are physically mounted in a tray with external connections available at the right rear of the machine. The tray contains a single controller board. An optional fax board may also be installed. Disk(s) are mounted on the underside of the tray.

Below the controller tray are other connectors that distribute power and communications to external options such as a finisher or high-capacity paper tray.

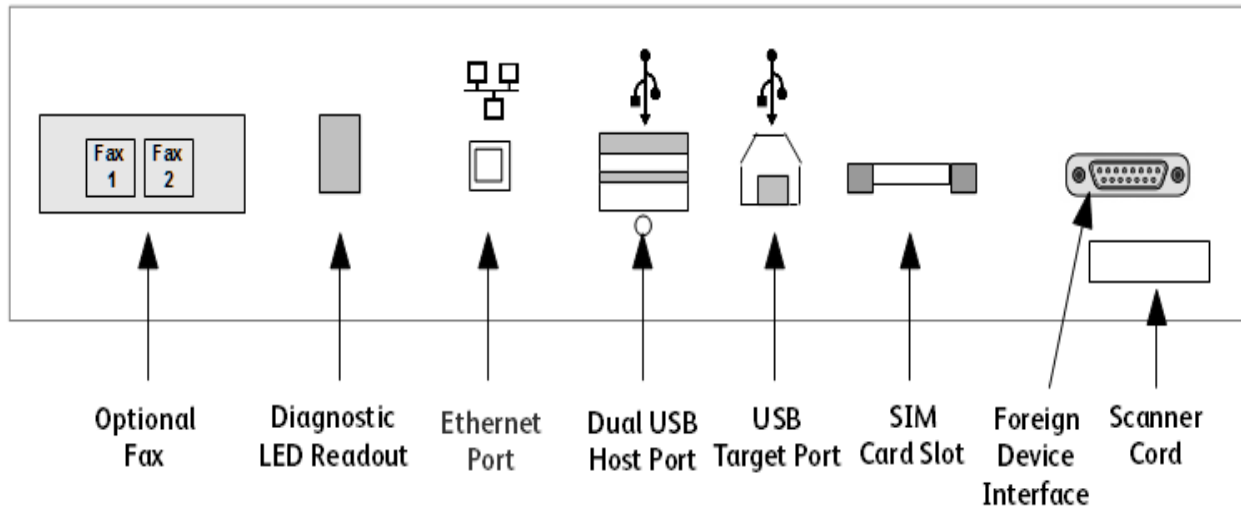

Figure 2-3 WorkCentre 5845/5855/5865/5875/5890 Back panel connections

Interface	Description / Usage
USB Target Port	Diagnostics and service; Xerox Copier Assistant
Dual USB Host Ports	Card readers; SW upgrade; USB Printing; Scan to USB
Debug Port	Troubleshooting and Monitoring
Ethernet Port	Network Connectivity
Diagnostic LED Readout	Displays status codes for Diagnostics
Foreign Device Interface (FDI)	Allows connection of optional access control hardware (accessory not present in evaluated TOE). Allows premium charge for Legal paper.
Scanner Cord	Interface to Scanner
SIM Card Slot	Options enablement
Optional Fax	Optional Fax Card

Table 4 Controller External Connections



## 2.2.4. USB Ports

The WorkCentre contains a host connector for a USB flash drive, enabling upload of software upgrades and download of network logs or machine settings files.

Autorun is disabled on this port. No executable files will be accepted by the port.

Modifying the software upgrade, network logging or saved machine settings files will make the files unusable on a WorkCentre .

The data in the network logging file is encrypted and can only be decrypted by Xerox service.

The machine settings that can be saved and restored by a service technician are limited to controller and fax parameters that are needed for normal operation. For example, the fax address book can be saved and restored by a service technician.

There is no method for a user, administrator or technician to move image data from the WorkCentre to a USB device.

USB Port(s)	
USB port and location	Purpose
Front panel – 1 Host port	User retrieves print ready files from Flash Media or stores scanned files on Flash Media. Physical security of this information is the responsibility of the user or operator.
Rear panel – 2 Host ports	User retrieves print ready files from Flash Media or stores scanned files on Flash Media. Physical security of this information is the responsibility of the user or operator. Optional security devices, such as a CAC reader, communicate with the machine via this port. No job data is transmitted across this interface when an optional security device is connected.
Rear panel – 1 Target port	User PC direct connection for printing, Xerox Customer Service Engineer PWS connection for problem diagnosis. The optional CopyAssistant kit communicates with the machine via this port. No job data is transmitted across this interface.
<b>Additional Information</b> A number of devices can be connected to the 3 USB Host ports. Once information has been copied (either as a back-up data set or as a transfer medium, physical security of this information is the responsibility of the user or operator.)	

**Table 5 USB Ports**

## 2.3. Fax Module

### 2.3.1. Purpose

The embedded FAX service uses the installed embedded fax card to send and receive images over the telephone interface. The FAX card plugs into a custom interface slot on the controller.

### 2.3.2. Hardware

The Fax Card is a printed wiring board assembly containing a fax modem and the necessary telephone interface logic. It connects to the controller via a serial communications interface. The Fax Card is responsible for implementing the T.30 fax protocol. All remaining fax-specific features are implemented in software on the controller. The fax telephone lines are connected directly to the Fax Card via RJ-11 connectors.

Name	Size	Purpose / Explanation
MODEM #1	NA	Optional Fax modem 2 ports

**Table 6 Fax Module components**

## 2.4. Scanner

### 2.4.1. Purpose

The purpose of the scanner is to provide mechanical transport to convert hardcopy originals to electronic data.

### 2.4.2. Hardware

The scanner converts the image from hardcopy to electronic data. A document handler moves originals into a position to be scanned. The scanner provides enough image processing for signal conditioning and formatting. The scanner does not store scanned images. All other image processing functions are in the copy controller.

## 2.5. Graphical User Interface (GUI)

### 2.5.1. Purpose

The GUI detects soft and hard button actuations, and provides text and graphical prompts to the user. The GUI is sometimes referred to as the Local UI (LUI) to distinguish it from the WebUI, which is exported by the web service that runs in the controller. Images are not transmitted to or stored in the GUI. The Start hard button is located on the GUI panel.

## 2.6. Marking Engine (Image Output Terminal or IOT)

### 2.6.1. Purpose

The Marking Engine performs copy/print paper feeding and transport, image marking and fusing, and document finishing. Images are not stored at any point in these subsystems.

### 2.6.2. Hardware

The marking engine is comprised of paper supply trays and feeders, paper transport, LED scanner, xerographics, and paper output and finishing. The marking engine contains a CPU, BIOS, RAM and Non-Volatile Memory.



## 2.7. System Software Structure

### 2.7.1. Open-source components

Open-source components in the connectivity layer implement high-level protocol services. The security-relevant connectivity layer components are:

- Apache 2.2.22
- PHP 5.3.13
- OpenSSL 0.9.8x (SSL)
- SAMBA 3.0.37 (SMB)
- Netsnmp 5.4 (SNMPv3)
- OpenLDAP 2.4.23
- Kerberos 5-1.8





## 2.7.2. Operating System Layer in the Controller

The OS layer includes the operating system, network and physical I/O drivers. The controller operating system is Wind River Linux, kernel v. 2.6.34+. Xerox may issue security patches for the OS, in which case the Xerox portion of the version number (i.e.. after the '+' sign) will be incremented.

The crypto library for IPSec is provided by the kernel.

IP Filtering is also provided by the kernel.

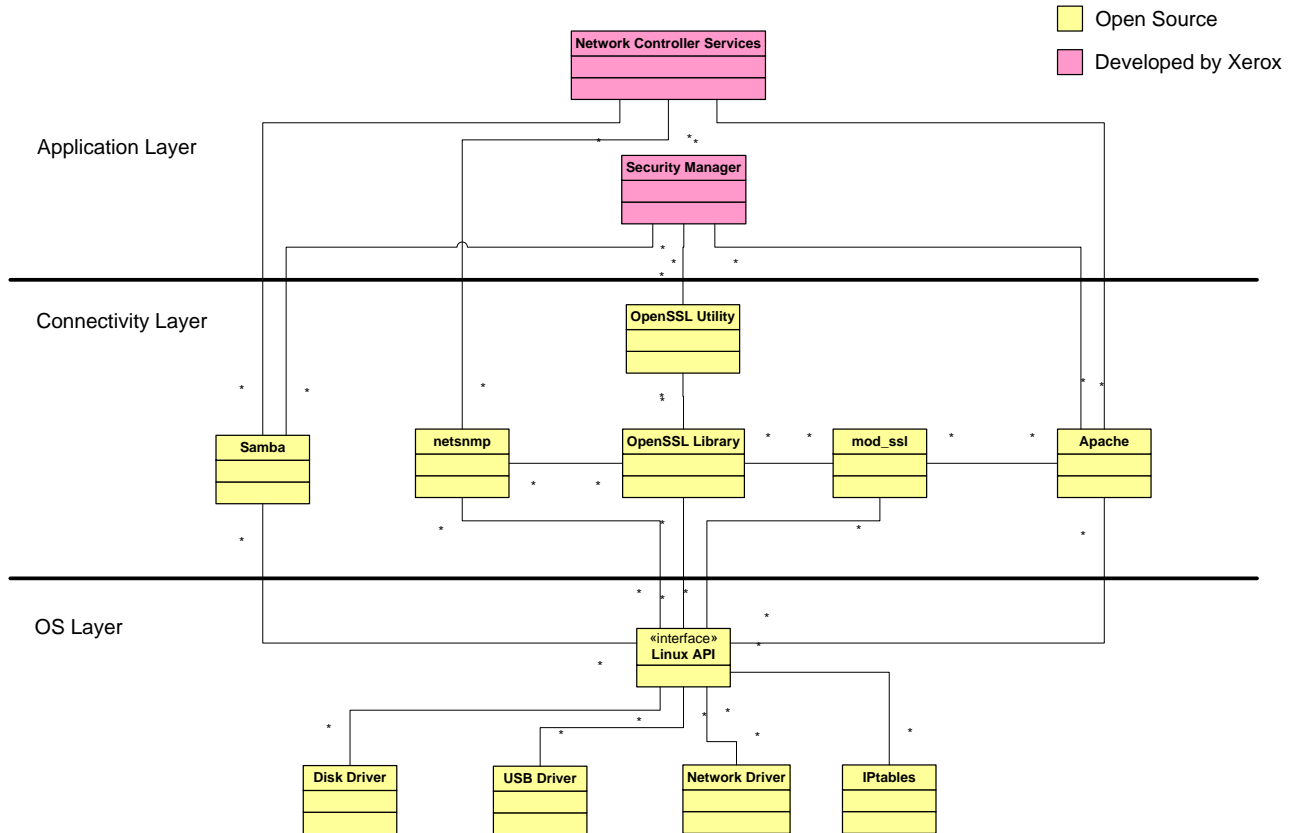

Figure 2-4 Controller Operating System layer components



### 2.7.3. Network Protocols

Figure 2-5 and Figure 2.6 are interface diagrams depicting the IPv4 and IPv6 protocol stacks supported by the device, annotated according to the DARPA model.

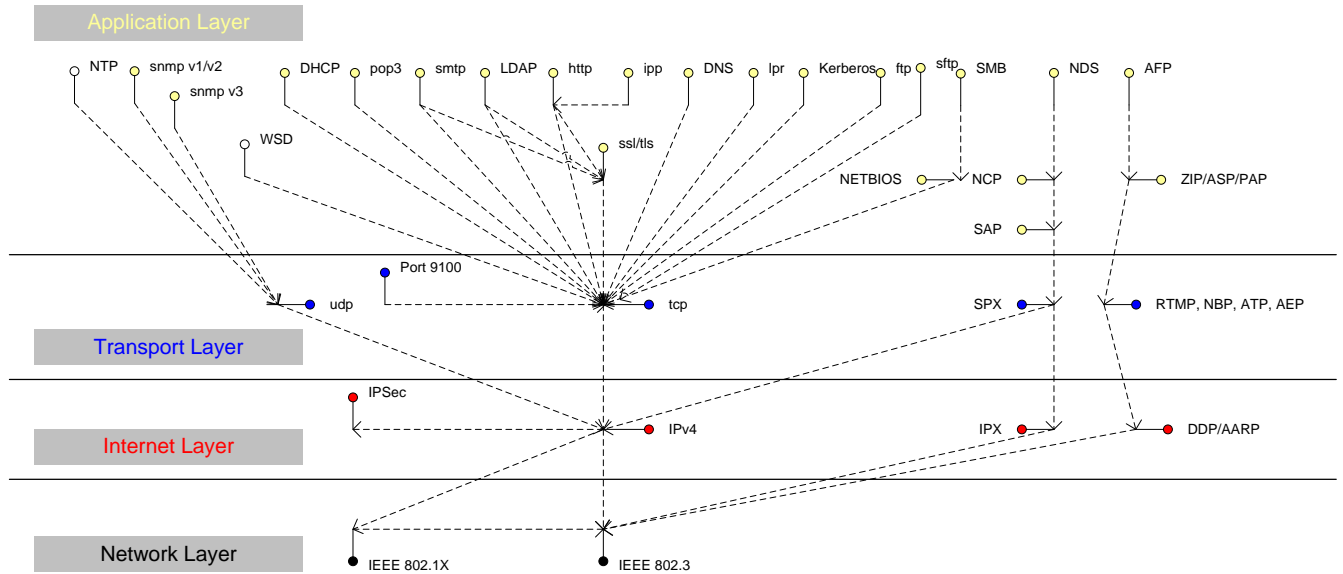

Figure 2-5 IPv4 Network Protocol Stack

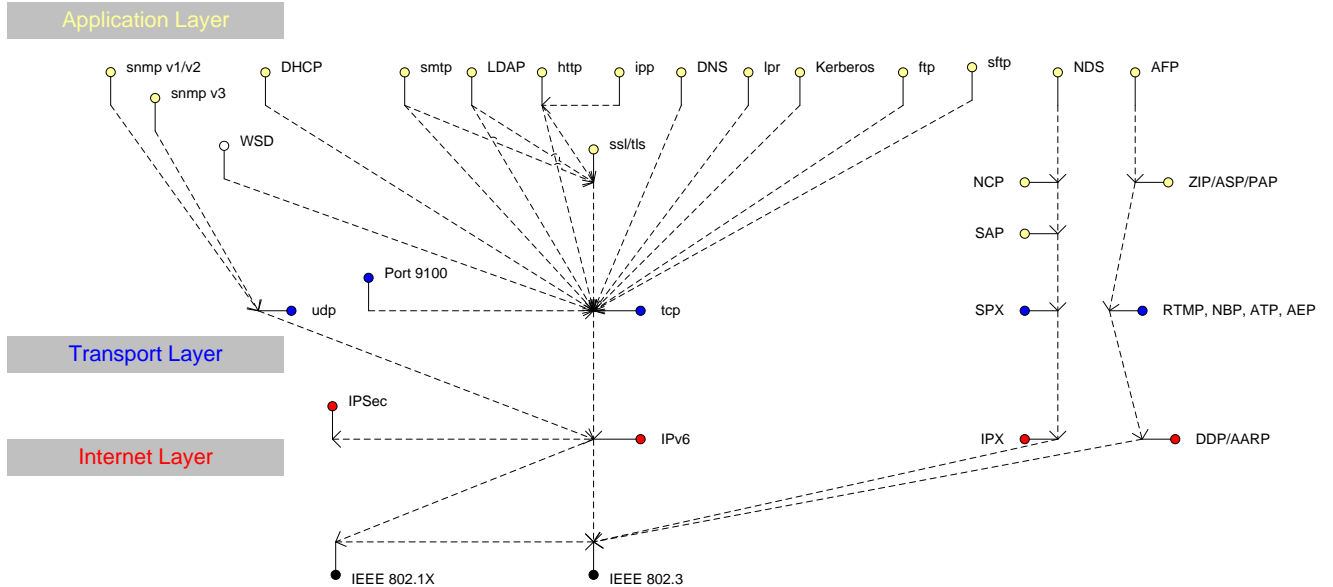

Figure 2-6 IPv6 Network Protocol Stack

## 2.8. Logical Access

### 2.8.1. Network Protocols

The supported network protocols are listed in Appendix D and are implemented to industry standard specifications (i.e. they are compliant to the appropriate RFC) and are well-behaved protocols. There are no 'Xerox unique' additions to these protocols.

#### 2.8.1.1. IPSec

The device supports IPSec tunnel mode. The print channel can be secured by establishing an IPSec association between a client and the device. A shared secret is used to encrypt the traffic flowing through this tunnel. SSL must be enabled in order to set up the shared secret.

When an IPSec tunnel is established between a client and the machine, the tunnel will also be active for administration with SNMPv2 tools (HP Open View, etc.), providing security for SNMP SETs and GETS with an otherwise insecure protocol. SNMP Traps may not be secure if either the client or the device has just been rebooted. IP Filtering can be useful to prevent SNMP calls from non-IPSec clients.

Once an IPSec channel is established between two points, it stays open until one end reboots or goes into power saver,. Only network clients and servers will have the ability to establish an IPSec tunnel with the machine. Thus device-initiated operations (like scanning) cannot assume the existence of the tunnel unless a print job (or other client initiated action) has been previously run since the last boot at either end of the connection.

## 2.8.2. Ports

The following table summarizes all potentially open ports and subsequent sections discuss each port in more detail. All ports can be disabled if not needed under control of the system administrator.

Default Port #	Type	Service name
22	TCP	SFTP
23	UDP	NTP
25	TCP	SMTP
53	UDP	DNS
68	UDP	DHC ACK Response to DHCP
80	TCP	HTTP
88	UDP	Kerberos
110	TCP	POP3 client – used for IFax
137	UDP	NETBIOS- Name Service
138	UDP	NETBIOS-Datagram Service; SMB filing and Scan template retrieval
139	TCP	NETBIOS Session Service - SMB Authentication, SMB filing
161	TCP/UDP	SNMP
389	UDP	LDAP
396	TCP	Netware
427	UDP	SLP
443	TCP	HTTPS - HTTP over SSL/TLS
445	TCP	Microsoft-DS
500	TCP	ISAKMP
515	TCP	LPR
631	TCP	IPP
1900	TCP/UDP	SSDP
1901	UDP	SSDP
3003	TCP	http/SNMP reply
3702	TCP/UDP	WSD Discovery
4500	TCP/UDP	IKE Negotiation Port for IPSec
5353	TCP/UDP	Multicast DNS
5354	TCP	Multicast DNS Responder IPC
5909-5999	Remote UI	Remote Access to Local UI. Ports randomized for security.
9100	TCP	raw IP
28002	TCP	WS: Scan Template Management, Scan Extension, Xerox Secure Access, Authentication & Authorization Configuration, Device Configuration
53202	TCP	WSD Transfer
53303	TCP	WSD Print
53404	TCP	WSD Scan
61100	TCP	WS: XEIP Proxy Configuration
61200	TCP	WS: User Interface Configuration
61400	TCP	WS: Digital Certificate Management
61502	TCP	WS: Extensible Service Registration
61503	TCP	WS: Session Data

**Table 7 Network Ports**

Please note that there is no ftp port in this list. ftp is only used to export scanned images and to retrieve Scan Job Templates, and will open port 21 on the remote device. An ftp port is never open on the controller itself.



#### **2.8.2.1. Port 22, SFTP**

This port is used to securely encrypt the user name, password, and data being transferred to a network server/repository.

#### **2.8.2.2. Port 23, NTP**

This port is used to retrieve the time from a network server.

#### **2.8.2.3. Port 25, SMTP**

This unidirectional port is open only when Scan to E-mail or Internet Fax (I-Fax) is exporting images to an SMTP server, or when email alerts are being transmitted. SMTP messages & images are transmitted to the SMTP server from the device.

#### **2.8.2.4. Port 53, DNS**

Designating a DNS server will allow the device to resolve domain names. This can be configured via the WebUI.

#### **2.8.2.5. Port 68, DHCP**

This port is used only when performing DHCP, and is not open all of the time. To permanently close this port, DHCP must be explicitly disabled. This is done in User Tools via the Local User Interface or via the TCP/IP page in the Properties tab on the WebUI.

### 2.8.2.6. Port 80, HTTP

The embedded web pages communicate to the machine through a set of unique APIs and do not have direct access to machine information:

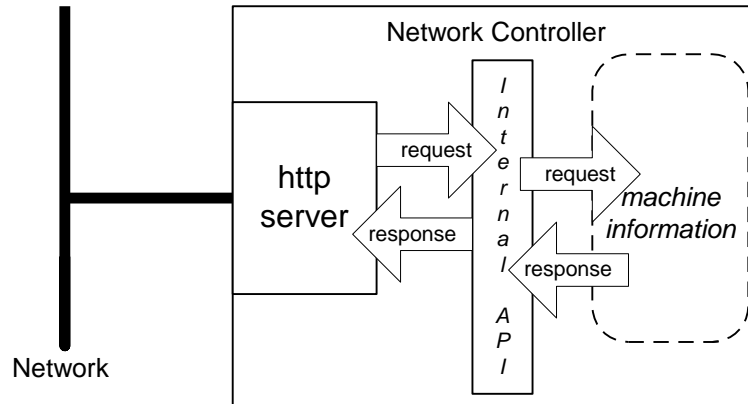

The HTTP port can only access the HTTP server residing in the controller. The embedded HTTP server is Apache. The purpose of the HTTP server is to:

- Give users information of the status of the device;
- View the job queue within the device and delete jobs;
- Allow users to upload print ready files and program Scan to File Job Templates;
- Allow remote administration of the device. Many settings that are on the Local UI are replicated in the device's web pages. Users may view the properties of the device but not change them without logging into the machine with administrator privileges.

The HTTP server can only host the web pages resident on the hard disk of the device. It does not and cannot act as a proxy server to get outside of the network the device resides on. Hence the server cannot access any networks (or web servers) outside of the customer firewall.

When the device is configured with an IP address, it is as secure as any device inside the firewall. The web pages are accessible only to authorized users of the network inside the firewall.

This service (and port) may be disabled in User Tools via the Local User Interface or via the TCP/IP page in the Properties tab on the WebU. Please note that when this is disabled, IPP Port 631 is also disabled.

HTTP may be secured to use HTTPS by enabling Secure Sockets Layer.

#### 2.8.2.5.1. Proxy Server

The device can be configured to communicate through a proxy server. Features that can make use of a proxy server include the Automatic Meter Read feature, scanning to a remote repository, or retrieving scan templates from a remote template pool.



### 2.8.2.7. Port 88 Kerberos

This port is only open when the device is communicating with the Kerberos server to authenticate a user, or to request a TGT / TGS to access the LDAP server. To disable this port, authentication must be disabled, and this is accomplished via the Local User Interface.

This version of software has Kerberos 5.1.1 with DES (Data Encryption Standard) and 64-bit encryption. The Kerberos code is limited to user authentication, and is used to authenticate a user with a given Kerberos server as a valid user on the network. Please note that the Kerberos server (a 3rd party device) needs to be set up for each user. Once the user is authenticated, the Kerberos software has completed its task. This code will not and cannot be used to encrypt or decrypt documents or other information.

This feature is based on the Kerberos program from the Massachusetts Institute of Technology (MIT). The Kerberos network authentication protocol is publicly available on the Internet as freeware at <http://web.mit.edu/kerberos/www/>.

**Please note:**

The device does not require much of the information provided by Kerberos for authenticating. For the most part, the device only uses information that indicates whether authentication has passed. Other information that the server may return (e.g. what services the user is authenticated for) is ignored or disabled in the Xerox implementation. This is not an issue since the only service a user is being authenticated for is access to an e-mail directory. No other network services are accessible from the Local UI.

Xerox has received an opinion from its legal counsel that the device software, including the implementation of a Kerberos encryption protocol in its network authentication feature, is not subject to encryption restrictions based on Export Administration Regulations of the United States Bureau of Export Administration (BXA). This means that it can be exported from the United States to most destinations and purchasers without the need for previous approval from or notification to BXA. At the time of the opinion, restricted destinations and entities included terrorist-supporting states (Cuba, Iran, Libya, North Korea, Sudan and Syria), their nationals, and other sanctioned entities such as persons listed on the Denied Parties List. Xerox provides this information for the convenience of its customers and not as legal advice. Customers are encouraged to consult with legal counsel to assure their own compliance with applicable export laws.

### 2.8.2.8. Port 110, POP-3 Client

This unidirectional port is used when receiving an Internet Fax (I-Fax) or E-Mail. These jobs may only be printed, and the port is only open if I-Fax is enabled and while receiving the job. It is not configurable.

### 2.8.2.9. Ports 137, 138, 139, NETBIOS

For print jobs, these ports support the submission of files for printing as well as support Network Authentication through SMB. Port 137 is the standard NetBIOS Name Service port, which is used primarily for WINS. Port 138 supports the CIFS browsing protocol. Port 139 is the standard NetBIOS Session port, which is used for printing. Ports 137, 138 and 139 may be configured in the Properties tab of the device's web page.

For Network Scanning features, ports 138 and 139 are used for both outbound (i.e. exporting scanned images and associated data) and inbound functionality (i.e. retrieving Scan Templates). In both instances, these ports are only open when the files are being stored to the server or templates are being retrieved from the Template Pool. For these features, SMB protocol is used.

### 2.8.2.10. Port 161, SNMP

This port support the SNMPv1, SNMPv2c, and SNMPv3 protocols. Please note that SNMP v1 does not have any password or community string control. SNMPv2 relies on a community string to keep unwanted people from changing values or browsing parts of the MIB. This community string is transmitted on the network in clear text so anyone sniffing the network can see the password. Xerox strongly recommends that the customer change the community string upon product installation. SNMP is configurable, and may be explicitly enabled or disabled in the Properties tab of the device's web pages.



SNMP traffic may be secured if an IPSec tunnel has been established between the agent (the device) and the manager (i.e. the user's PC).

The device supports SNMPv3, which is an encrypted version of the SNMP protocol that uses a shared secret. Secure Sockets Layer must be enabled before configuring the shared secret needed for SNMPv3.

#### **2.8.2.11. Port 389, LDAP**

This is the standard LDAP port used for address book queries in the Scan to Email feature.

#### **2.8.2.12. Port 396, Netware**

This configurable port is used when Novell Netware is enabled to run over IP.

#### **2.8.2.13. Port 427, SLP**

When activated, this port is used for service discovery and advertisement. The device will advertise itself as a printer and also listen for SLP queries using this port. It is not configurable. This port is explicitly enabled / disabled in the Properties tab of the device's web pages.

#### **2.8.2.14. Port 443, HTTPS – HTTP over SSL/TLS**

This is the default port for Secure Sockets Layer communication. This port can be configured via the device's web pages. SSL must be enabled before setting up either SNMPv3 or IPSec or before retrieving the audit log (see Sec. 4.2). SSL must also be enabled in order to use any of the Web Services (Scan Template Management, Automatic Meter Reads, or Network Scanning Validation Service).

SSL should be enabled so that the device can be securely administered from the web UI. When scanning, SSL can be used to secure the filing channel to a remote repository.

SSL uses X.509 certificates to establish trust between two ends of a communication channel. When storing scanned images to a remote repository using an https: connection, the device must verify the certificate provided by the remote repository. A Trusted Certificate Authority certificate should be uploaded to the device in this case.

To securely administer the device, the user's browser must be able to verify the certificate supplied by the device. A certificate signed by a well-known Certificate Authority (CA) can be downloaded to the device, or the device can generate a self-signed certificate. In the first instance, the device creates a Certificate Signing Request (CSR) that can be downloaded and forwarded to the well-known CA for signing. The signed device certificate is then uploaded to the device. Alternatively, the device will generate a self-signed certificate. In this case, the generic Xerox root CA certificate must be downloaded from the device and installed in the certificate store of the user's browser.

The device supports only server authentication.

#### **2.8.2.15. Port 445, NETBIOS (Microsoft – DS)**

This port is open and used only when NETBIOS (Microsoft Networking/Active Directory) is enabled.

#### **2.8.2.16. Ports 500/4500, ISAKMP**

ISAKMP defines the procedures for authenticating a communicating peer, creation and management of Security Associations, key generation techniques, and threat mitigation (e.g. denial of service and replay attacks). ISAKMP defines procedures and packet formats to establish, negotiate, modify and delete Security Associations. ISAKMP can be implemented over any transport protocol. All implementations must include send and receive capability for ISAKMP using UDP on port 500. Port 500 will only be open on the device if the IPSec service is enabled.

#### **2.8.2.17. Port 515, LPR**

This is the standard LPR printing port, which only supports IP printing. It is a configurable port, and may be explicitly enabled or disabled in the Properties tab of the device's web pages.



### 2.8.2.18. Port 631, IPP

This port supports the Internet Printing Protocol. It is not configurable. This is disabled when the http (web) server is disabled.

### 2.8.2.19. Port 1900, SSDP

This port behaves similarly to the SLP port. When activated, this port is used for service discovery and advertisement. The device will advertise itself as a printer and also listen for SSDP queries using this port. It is not configurable. This port is explicitly enabled / disabled in the Properties tab of the device's web pages.

### 2.8.2.20. Port 3003, HTTP/SNMP reply

This port is used when the http server requests device information. The user displays the Web User Interface (WebUI) and goes to a page where the http server must query the device for settings (e.g. Novell network settings). The http server queries the machine via an internal SNMP request (hence this port can only open when the http server is active). The machine replies back to the http server via this port. It sends the reply to the loopback address (127.0.0.0), which is internally routed to the http server. This reply is never transmitted on the network. Only SNMP replies are accepted by this port, and this port is active when the http server is active (i.e. if the http server is disabled, this port will be closed). If someone attempted to send an SNMP reply to this port via the network, the reply would have to contain the correct sequence number, which is highly unlikely, since the sequence numbers are internal to the machine.

### 2.8.2.21. Port 3702, WSD Discovery, WS Discovery Multicast

This is the default port for WS-Discovery (the discovery of services in an ad hoc network with a minimum of networking services (for example, no DNS, UDDI or other directory services). It does this by announcing or advertising the existence of the printer and its services on the network when it becomes available, and announcing its departure when unavailable. The default state is selected (enabled).

### 2.8.2.22. Port 4500 ISAKMP

See Port 500. Port 4500 is an alternate port for port 500.

### 2.8.2.23. Port 5353 Multicast DNS, 5354 Multicast DNS Responder IPC

Multicast DNS provides the ability to address hosts using DNS-like names without the need of an existing, managed DNS server. The Multicast DNS Responder is a client in the printer that replies to multicast DNS requests for services on the local network. The multicast DNS requests and replies conform to RFC 1034 and RFC 2782 and are broadcast to the destination IP address 224.0.0.251 on port 5353. The se ports will only be open if the Multicast DNS service is enabled.

### 2.8.2.24. Port 5909-5999 Remote View of Local UI

This allows (if enabled by the system administrator) the Local UI (Control Panel) through a Web Browser to view and control the device. The ports are randomized at each use for security puposes.

### 2.8.2.25. Port 9100, raw IP

This allows downloading a PDL file directly to the interpreter. This port has limited bi-directionality (via PJJ back channel) and allows printing only. This is a configurable port, and may be disabled in the Properties tab of the device's web pages.

### 2.8.2.26. Port 28002, WS

Web Service interface(s) used to programmatically configure device usage of Workflow Scanning features such as template management.



#### **2.8.2.27. Ports 53202, 53303, 53404, WSD**

Transfer Web Service (53202) and Print Web Service (53303 and 53404) for Microsoft WSD support.

#### **2.8.2.28. Port 61100, WS**

Web Service interface(s) used to get/set proxy configuration specific to Extensible Interface Platform services.

#### **2.8.2.29. Port 61200, WS**

Web Service interface(s) used to get physical UI configuration information.

#### **2.8.2.30. Port 61400, WS**

Web Service interface(s) used to get/set digital certificates.

#### **2.8.2.31. Port 61502, WS**

Web Service interface(s) used to get/set services available on the device.

#### **2.8.2.32. Port 61503, WS**

Web Service interface(s) used to get session information applicable to the current active session on the device.

### **2.8.3. IP Filtering**

The devices contain a static host-based firewall that provides the ability to prevent unauthorized network access based on IP address and/or port number. Filtering rules can be set by the SA using the WebUI. An authorized SA can create rules to (Accept / Reject / Drop) for ALL or a range of IP addresses. In addition to specifying IP addresses to filter, an authorized SA can enable/disable all traffic over a specified transport layer port

This may be done through the Web UI under the Properties tab in the Security area.

# 3. System Access

## 3.1. Authentication Model

The authentication model allows for both local and network authentication and authorization. In the local and network cases, authentication and authorization take place as separate processes: a user must be authenticated before being authorized to use the services of the device.

If the device is set for local authentication, user account information will be kept in a local accounts database (see the discussion in Chapter 4 of Xerox Standard Accounting) and the authentication process will take place locally. The system administrator can assign authorization privileges on a per user basis. User access to services will be provided based on the privileges set for each user in the local accounts database. .

When the device is set for network authentication, the user's network credentials will be used to authenticate the user at the network domain controller.

Users can be authorized on an individual basis to access one or any combination of the available services such as: Copy, Fax, Server Fax, Reprint Saved Jobs, Email, Internet Fax, Workflow Scanning Server, Extensible Interface Platform Services.

Also users can be authorized to access one or any combination of the following machine pathways: Services, Job Status, or Machine Status.

User Permissions, the new authorization method determines your authorization by Role. Roles are stored in the local account database and users are either directly assigned to the roles in the database, or the role is associated with an LDAP/SMB group. Once the device determines what group the user is a member of, it determines what roles in the local database are associated with that group and define access based on the roles. Assignment of users to the System Administrator role or the Accounting Administrator is also managed via User Permissions.

Figure 3-1 provides a schematic view of the authentication and authorization subsystem. Use of the local accounts database or the network can be set independently for both authentication and authorization, meaning that it is possible to enable network authentication and local authorization, or vice versa. Usually the device will be set for both authentication and authorization to take place against the same database, either local or network.

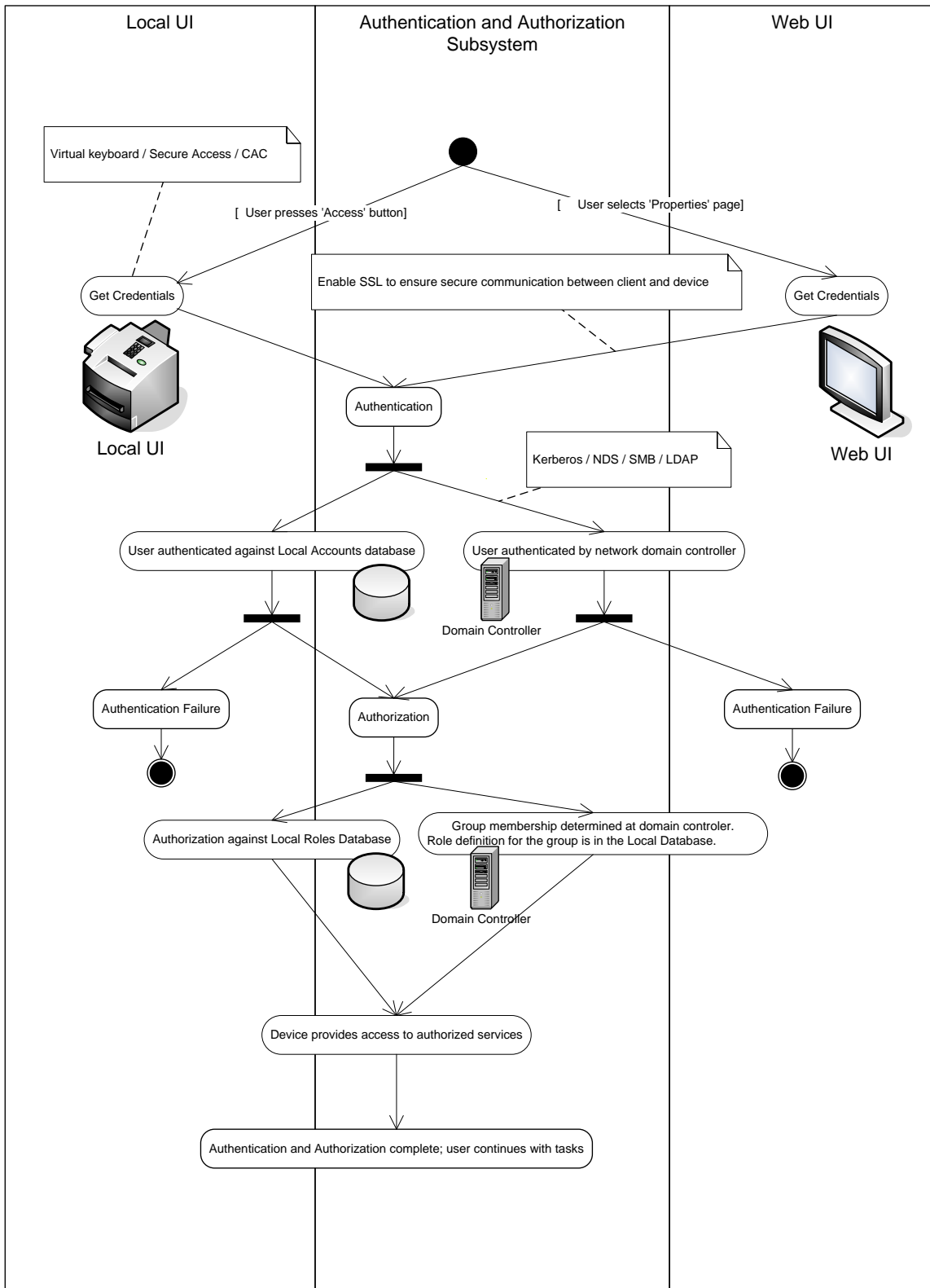

Figure 3-1 Authentication and Authorization schematic

## 3.2. Login and Authentication Methods

There are a number of methods for different types of users to be authenticated. In addition, the connected versions of the product also log into remote servers. A description of these behaviors follows.

### 3.2.1. System Administrator Login [All product configurations]

System Administrator Login and access to Tools requires use of either a reserved account “admin”, or login into an account with SA privileges defined in the role. It is strongly recommended that the default password is changed to a strong alphanumeric password for the “admin” account. The same name and password is used to access CWIS.

A Card reader is available for customers so the user can authenticate to the device with a CAC/PIV/.NET card and PIN.

### 3.2.2. User authentication

Users may authenticate to the device using Kerberos, LDAP, SMB Domain, or NDS authentication protocols.

For Kerberos and SMB the WebUI allows an SA to set up a default authentication domain and as many as 8 additional alternate authentication domains.

#### 3.2.2.1. Kerberos Authentication (Solaris or Windows)

The authentication steps are:

- 1) A User enters a user name and password at the device in the Local UI. The device sends an authentication request to the Kerberos Server.
- 2) The Kerberos Server responds with an encrypted key for the user attempting to sign on.
- 3) The device attempts to decrypt the key using the entered password. The device sends the decrypted key back to the server. The user is authenticated if the credentials were properly decrypted. The server responds by granting a Ticket Granting Ticket to the device.
- 4) The device then logs onto and queries the LDAP server trying to match an email address against the user's Login Name. The user's email address will be retrieved if the personalization option has been selected on the Authentication Configuration page.
- 5) If the LDAP Query is successful, the user's email address is placed in the From: field. Otherwise, the user's login name along with the system domain is used in the From: field.
- 6) The user may then add recipient addresses by accessing the Address Book on the LDAP server. Please see the User Manual for details. Each addition is a separate session to the LDAP server.

### 3.2.2.2. SMB Authentication (Windows 2000/Windows 2003/Windows 2008)

The authentication steps vary somewhat, depending on the network configuration. Listed below are 3 network configurations and the authentication steps.

#### Basic Network Configuration: Device and Domain Controller are on the same Subnet

##### Authentication Steps:

- 1) The device broadcasts an authentication request that is answered by the Domain Controller.
- 2) The Domain Controller responds back to the device whether or not the user was successfully authenticated.

If (2) is successful, steps 3 – 5 proceed as described in steps 4 – 6 of the Kerberos section.

#### Device and Domain Controller are on different Subnets, SA defines IP Address of Domain Controller

##### Authentication Steps:

- 1) The device sends an authentication request directly to the Domain Controller through the router using the IP address of the Domain Controller.
- 2) The Domain Controller responds back to the device through the router whether or not the user was successfully authenticated.

If (2) is successful, steps 3 – 5 proceed as described in 4 - 6 of Kerberos section.

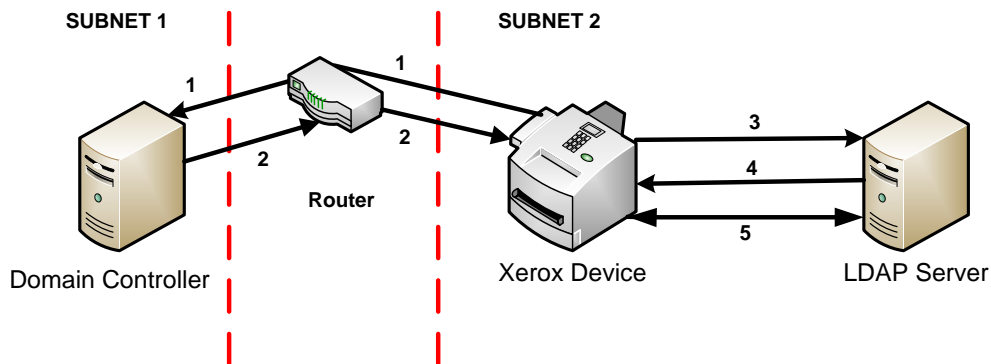

## Device and Domain Controller are on different Subnets, SA defines Hostname of Domain Controller

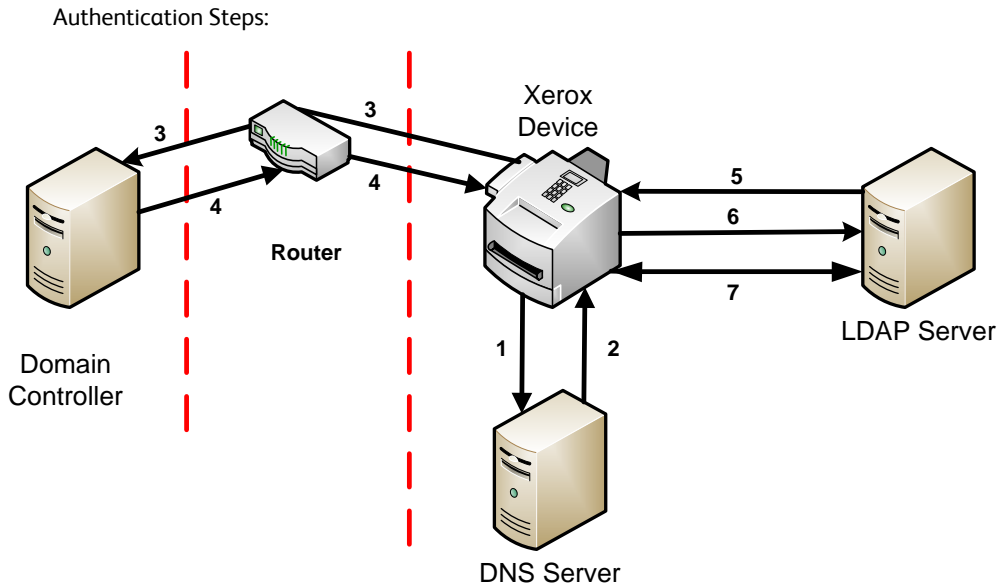

- 1) The device sends the Domain Controller hostname to the DNS Server.
- 2) The DNS Server returns the IP Address of the Domain Controller
- 3) The device sends an authentication request directly to the Domain Controller through the router using the IP address of the Domain Controller.
- 4) The Domain Controller responds back to the device through the router whether or not the user was successfully authenticated.

If (4) is successful, steps 5 – 7 proceed as described in steps 4 - 6 of the Kerberos section.



### 3.2.2.3. Common Access Card (CAC1/PIV/.NET)

With the addition of the CAC accessory kit, the device is able to utilize the following cards:

- [Axalto Access 64kV2](#)
- [Oberthur PIV V1.08](#)
- [Gemalto PIV 144K](#)
- [Gemalto Access 64KV2](#)
- [Gemalto .NET v2](#)
- [Gemplus GXP3 64V2N](#)
- [Oberthur ID One V5.2](#)
- [Oberthur ID One 128K](#)
- [Oberthur ID-One Cosmo 64 V5.2 D with OCS Applets](#)
- [Gemplus GCX4](#)
- [Oberthur ID-One Cosmo 64 V5.2 D with ActivIdentity Applets](#)
- [Gemplus GCX4 72K with ActivIdentity Applets](#)
- [Oberthur ID-One Cosmo v7.0 128K with ActivIdentity Applets](#)
- [GnD SmartCafe Expert v3.2 144KB with ActivIdentity Applets](#)
- [Gemalto TOP DL GX4 FIPS with ActivIdentity Applets](#)
- [GnD SCE 3.2 80K with ActivIdentity Applets](#)
- [Oberthur 7.0 PIV with Oberthur Applets](#)
- [Oberthur D1 72K/V2 \(contact-less and PIV\)](#)
- [Gemalto .NET v1](#)

Sending encrypted data to multiple recipients is made possible using an organizations LDAP directory.

The user may view certificates of potential recipients to ensure they are sent to the intended parties. Controls are also in place to prevent sending to users without encryption certificates

Audit logs record which e-mails were sent encrypted and those that were not.

In addition, Confirmation Reports detail which recipients received e-mail and if it was encrypted or not.





#### **3.2.2.4. Xerox Secure Access**

Via Xerox Secure Access a customer can enable additional authentication methods to the device with minimal impact on the system software. By using a Web Service and 3rd party equipment, any authentication method that complies with the established interface into the device can be used. This includes biometric and card access.

Xerox Secure Access is a Web Service that allows a 3rd party to use its own mechanisms, including accessing the customers authentication servers, to authenticate a user. The device can also take in additional information about the user to allow for two-factor authentication.

The Web Service interface allows the 3rd party to tell the device that someone was successfully logged in, who logged in and inform the device of logon issues using error messages.

The authentication steps are:

- 1) The device presents the appropriate screens to tell the user what needs to be done to authenticate.
- 2) The user follows the authentication instructions like swiping a card and/or entering a PIN or password.
- 3) User is authenticated and the device will complete any Authorization and Personalization as would have been done if the user authenticated using a system supplied solution.

#### **3.2.2.5. DDNS**

The implementation in the device does not support any security extensions.

## 3.3. System Accounts

### 3.3.1. Printing

The device may be set up to connect to a print queue maintained on a remote print server. The login name and password are sent to the print server in clear text. IPSec should be used to secure this channel.

### 3.3.2. Network Scanning

Network Scanning may require the device to log into a server. The instances where the device logs into a server are detailed in the following table. Users may also need to authenticate for scanning. This authentication is detailed in subsequent sections.

#### 3.3.2.1. Device log on

Scanning feature	Device behavior
Scan to File, Public Template	The device logs in to the scan repository as set up by the SA in the Properties tab on the WebUI. The credentials may be the user's credentials or system credentials.
Scan to E-mail, I-Fax	<p>The device logs into an LDAP Server as set up by the SA in User Tools. It will log into the Server when a user is authenticated and the device is configured for Remote Authorization or Personalization is enabled, and when the user attempts to access LDAP based scan-to-email address books. At the time the LDAP server must be accessed, the device will log into (bind to)_ the LDAP server.</p> <p>The device uses a simple bind to the LDAP server unless the device was able to obtain a TGS for the LDAP server from the Kerberos Server. In this case a SASL (GSSAPI) bind is performed. A network username and password may be assigned to the device. The device logs in as a normal user, with read only privileges. User credentials may be used if configured by the SA for this authentication step.</p> <p>The device then logs into the SMTP server as set up by the SA in the Properties tab on the WebUI. The credentials may be the user's credentials or system credentials.</p>
Scan to Fax Server	The device logs in to the Fax Server as set up by the SA from the Properties tab on the WebUI. The credentials may be the user's credentials or system credentials.

Please note that when the device logs into any server the device username and password are sent over the network in clear text unless:

- SSL has been enabled
- IPSec has been configured to encrypt the traffic
- The device is logging into an SMB Server in which case the credentials are hashed.
- The device is using NTLM to login to the SMTP server (the device negotiates the most secure authentication method that both the device and server support).
- The LDAP server is being accessed via SASL.

#### 3.3.2.2. Scan Template Management

This is a web service that allows the SA to manage templates stored in a remote template pool. The connection to the remote pool can be secured with SSL.

# 4. Security Aspects of Selected Features

## 4.1. McAfee Enhanced Security / Integrity Control

Xerox has partnered with industry leader McAfee to include the Enhanced Security feature which uses McAfee Embedded Control, the same technology you can purchase for your computer. The McAfee agent is included with the device software which enables communication with McAfee tools such as the ePolicy Orchestrator.

The McAfee Enhanced Security and optional Integrity Control features use “whitelisting” technology to protect your Xerox devices from attack. On the Xerox device, there are critical files and directories designated read-only and some designated write-only. If attempts are made to write to a read-only or read from a write-only file or directory, in addition to being prevented, this creates an event which will be recorded in the device Audit Log. Further, if e-mail alerts are configured on the Xerox device, an e-mail would be sent to the configured address with details of the event.

Software upgrades are handled by designating the software upgrade process as a trusted updater. Once the digital signature is verified, the new software is installed and with it, a new whitelist for the new version. The digital signature prevents corrupted files from being installed by verification that the file is genuine Xerox software and has not been modified.

The use of digital signatures and the whitelisting technique, to stop unauthorized reads, writes, and optionally execution, prevents malicious code from harming your device, regardless of where the attack originated.

### 4.1.1 Enhanced Security

The Xerox Embedded Control feature is installed and enabled by default. This feature prohibits unauthorized reads, writes and modifications to critical control and configuration files on the device. The system also allows for an e-mail address to be configured so that alerts may be sent when unauthorized access is attempted. Details for configuration are contained in the **McAfee Embedded Control** section of the System Administrators Guide for your Xerox device.

### 4.1.2 Integrity Control (Optional Feature)

Integrity Control is a purchasable software option that combines the standard Enhanced Security features with the ability to monitor and prevent unauthorized execution of files that were not part of the standard Xerox device software.

### 4.1.3 ePolicy Orchestrator

To enable ePolicy Orchestrator, download and install the Xerox extensions for McAfee ePO. Details for this are available in the System Admin Guide in the section entitled **Configuring for McAfee ePO Server Alerts**.

## 4.2. Audit Log

The device maintains a security audit log. Recording of security audit log data can be enabled or disabled by the SA. The audit log is implemented as a circular log containing a maximum of 15000 event entries, meaning that once the maximum number of entries is reached, the log will begin overwriting the earliest entry. Only an SA will be authorized to download the log from the device. The log may only be exported over an https: connection, so SSL must be set up before retrieving the log. The log is exported in Comma-Separated Value (CSV) file format. The log does not clear when it is disabled, and will persist through power cycles.

The following table lists the events that are recorded in the log:

Event ID	Event description	Entry Data
1	System startup	Device name Device serial number
2	System shutdown	Device name Device serial number
3	Manual ODIO Standard started	Device name Device serial number
4	Manual ODIO Standard complete	Device name Device serial number Overwrite Status
5	Print job	Job name User Name Completion Status IIO status Accounting User ID Accounting Account ID
6	Network scan job	Job name User Name Completion Status IIO status Accounting User ID Accounting Account ID total-number-net-destination net-destination.
7	Server fax job	Job name User Name Completion Status IIO status Accounting User ID Accounting Account ID Total-fax-recipient-phone-numbers fax-recipient-phone-numbers net-destination.
8	IFAX	Job name User Name Completion Status IIO status Accounting User ID Accounting Account ID total-number-of-smtp-recipients smtp-recipients



Event ID	Event description	Entry Data
9	Email job	Job name User Name Completion Status IIO status Accounting User ID Accounting Account ID total-number-of-smtp-recipients smtp-recipients
10	Audit Log Disabled	Device name Device serial number
11	Audit Log Enabled	Device name Device serial number
12	Copy	Job name User Name Completion Status IIO status Accounting User ID Accounting Account ID Total-fax-recipient-phone-numbers fax-recipient-phone-numbers
13	Efax	Job name User Name Completion Status IIO status Accounting User ID Accounting Account ID Total-fax-recipient-phone-numbers fax-recipient-phone-numbers
14	Lan Fax Job	Job name User Name Completion Status IIO status Accounting User ID Accounting Account ID Total-fax-recipient-phone-numbers fax-recipient-phone-numbers
15	Data Encryption enabled	Device name Device serial number
16	Manual ODIO Full started	Device name Device serial number
17	Manual ODIO Full complete	Device name Device serial number Overwrite Status
18	Data Encryption disabled	Device name Device serial number
20	Scan to Mailbox job	Job name or Dir name User Name Completion Status IIO status
21	Delete File/Dir	Job name or Dir name User Name Completion Status IIO status
23	Scan to Home	UserName Device name Device serial number Completion Status (Enabled/Disabled)



Event ID	Event description	Entry Data
24	Scan to Home job	Job name or Dir name User Name Completion Status (Normal/Error) IIO status Accounting User ID-Name Accounting Account ID-Name total-number-net-destination net-destination
25	Copy store job	Job name or Dir name User Name Completion Status (Normal/Error) IIO status
26	PagePack login	Device name Device serial number Completion Status: Success: (if Passcode is ok) Failed: (if Passcode is not ok) Locked out (if Max Attempts Exceed 5) Time Remaining: Hrs (Remaining for next attempt) Min (Remaining for next attempt)
27	Postscript Passwords	Device name Device serial number StartupMode (enabled/disabled) System Params Password changed Start Job Password changed
29	Network User Login	UserName Device name Device serial number Completion Status (Success, Failed)
30	SA login	UserName Device name Device serial number Completion Status (Success or Failed)
31	User Login	UserName Device name Device serial number Completion Status (Success or Failed)
32	Service Login	Service name Device name Device serial number Completion status (Success or Failed).
33	Audit log download	UserName Device name Device Serial Number Completion status (Success or Failed).
34	IIO feature status	UserName Device name Device serial number IIO Status (enabled or disabled)
35	SA pin changed	UserName Device name Device serial number Completion status
36	Audit log Saved	UserName Device name Device serial number Completion status



Event ID	Event description	Entry Data
37	SSL	UserName Device name Device serial number Completion Status (Enabled/Disabled/Terminated)
38	X509 certificate	UserName Device name Device serial number Completion Status (Created/uploaded/Downloaded).
39	IP sec Enable/Disable/Configure	UserName Device name Device serial number Completion Status (Configured/enabled/disabled/Terminated)
40	SNMPv3	UserName Device name Device serial number Completion Status (Configured/enabled/disabled).
41	IP Filtering Rules	UserName Device name Device serial number Completion Status (Configured/enabled/disabled).
42	Network Authentication Enable/Disable/Configure	UserName Device name Device serial number Completion Status (Enabled/Disabled)
43	Device clock	UserName Device name Device serial number Completion Status (time changed/date changed)
44	SW upgrade	Device name Device serial number Completion Status (Success, Failed)
45	Cloning	Device name Device serial number Completion Status (Success, Failed)
46	Scan Metadata Validation	Device name Device serial number Completion Status (Metadata Validation Success or Failed)
47	Xerox Secure Access Enable/Disable/Configure	Device name Device serial number Completion status (Configured/enabled/disabled)
48	Service login copy mode	Service name Device name Device serial number Completion Status (Success, Failed)
49	Smartcard (CAC/PIV) access	UserName (if valid Card and Password are entered) Device name Device serial number Process Name
50	Process terminated	Device name Device serial number Process name
51	ODIO scheduled	Device name Device serial number ODIO type (Full or Standard) Scheduled time ODIO status (Started/Completed/canceled) Completion Status (Success/Failed/Canceled)

Event ID	Event description	Entry Data
53	CPSR Backup	File Name User Name Completion Status (Normal / Error) IIO Status
54	CPSR Restore	File Name User Name Completion Status (Normal / Error) IIO Status
55	SA Tools Access Admin	Device serial number Completion Status (Locked/Unlocked)
57	Session Timer Logout	Device Name Device Serial Number Interface (Web, LUI) User Name (who was logged out) Session IP (if available)
58	Session Timer Interval Change	Device Name Device Serial Number Interface (Web, LUI)(Timer affected by change) User Name (who made this change) Session IP (if available) Completion Status
59	Feature Access Control Enable/Disable/Configure	User Name Device Name Device Serial Number Completion Status (Enabled/Disabled/Configured) Interface (Web, Local, CAC, SNMP) Session IP address (if available)
60	Device Clock NTP Enable/Disable	Device Name Device serial number Enable/Disable NTP NTP Server IP Address Completion Status (Success/Failed)
61	Grant / Revoke Admin	Device Name Device Serial Number User Name (of target user) Grant or Revoke (the admin right) Completion Status (Success/Failed)
62	Smartcard (CAC/PIV) Enable/Disable/Configure	UserName Device Name Device Serial Number Completion Status (Success/Failed)
63	IPv6 Enable/Disable/Configure	UserName Device Name Device Serial Number Completion Status (Success/Failed)
64	802.1x Enable/Disable/Configure	UserName Device Name Device Serial Number Completion Status (Success/Failed)
65	Abnormal System Termination	Device Name Device Serial Number
66	Local Authentication	UserName Device Name Device Serial Number Completion Status (Enabled/Disabled)
67	Web User Interface Authentication (Enable Network or Local)	UserName Device Name Device Serial Number Authentication Method Enabled (Network/Local)





Event ID	Event description	Entry Data
68	FIPS Mode Enable/Disable/Configure	UserName Device name Device Serial Number Enable/Disable/Configure
69	Xerox Secure Access Login	UserName Device Name Device Serial Number Completion Status (Success/Failed)
70	Print from USB Enable/Disable	User Name Device Name Device Serial Number Completion Status (Enabled/Disabled)
71	USB Port Enable/Disable	User Name Device Name Device Serial Number USB Port (Front/Rear) Completion Status (Enabled/Disabled)
72	Scan to USB Enable/Disable	User Name Device Name Device Serial Number Completion Status (Enabled/Disabled)
73	System Log Download	Username IP of requesting device (if available) File names downloaded Destination (IP address or USB device) Completion status (Success/failed)
74	Scan to USB Job	Job Name User Name Completion Status IIO Status Accounting User ID-Name Accounting Account ID-Name
75	Remote UI feature	User Name Device Name Device Serial Number Completion Status (Enabled/Disabled/Configured)
76	Remote UI session	User Name Device Name Device Serial Number Completion Status (Initiated/Terminated) Remote Client IP Address
77	Remote Scan Feature Enable/Disable (TWAIN driver)	User Name Device Name Device Serial Number Completion Status (Enable/Disable)
78	Remote Scan Job Submitted (TWAIN driver)	UserName (at client if available) IP address of submitting client Device name Device serial number Job name (if accepted) Completion status (accept/reject request)
79	Scan to Web Service Job (Remote Scan Job Completed) (TWAIN driver)	Job name UserName Accounting User ID-Name Accounting Account ID-Name Completion status Destination



Event ID	Event description	Entry Data
80	SMTP Connection Encryption	UserName Device name Device serial number Completion Status (Enabled for STARTLS / Enabled for STARTLS if Avail / Enabled for SSL/TLS / Disabled)
81	Email Domain Filtering Rule	User name Device Name Device Serial Number Completion Status (Feature Enabled/Feature Disabled, Rule Added / Rule Deleted)
82	Software Self Test Started	Device Name Device Serial Number
83	Software Self Test Complete	Device Name Device Serial Number Completion Status(Success/Failed/Cancelled)
84	McAfee Security State	UserName Device name Device serial number Security Mode (Enhanced Security / Integrity Control) Completion Status (Enabled / Disabled / Pending)
85	McAfee Security Event	Device name Device serial number Type (Read / Modify / Execute / Deluge) McAfee message text
87	McAfee Agent	User name Device name Device serial number Completion Status (Enabled / Disabled)
88	Digital Certificate Import Failure	Device name
89	User Name Add/Delete	Device serial number
90	User Name Password Change	Security Mode
91	EFax Job Secure Print Passcode	UserName (managing passcodes) Device name Device serial number Completion Status (Passcode Created/Changed)
92	Scan2Mailbox Folder Password Change	UserName (managing passwords) Device name Device serial number Folder Name Completion Status (Password was Changed)
93	EFax Mailbox Passcode	UserName (managing passcodes) Device name Device serial number Completion Status (Passcode Created/Changed)
94	FTP/SFTP Filing Passive Mode	User Name Device Name Device Serial Number Completion Status (Enabled / Disabled)
95	EFax Forwarding Rule	User Name Device Name Device Serial Number Fax Line 1 or 2 (if applicable) Completion Status (Rule Edit / Rule Enabled / Rule Disabled)

Event ID	Event description	Entry Data
96	EIP Weblets Allow Install	UserName Device name Device serial number Completion Status (Enable Installation / Block Installation)
97	EIP Weblets Install	UserName Device name Device serial number Weblet Name Action (Install / Delete) Completion (Success / Fail)
98	EIP Weblets Enable / Disable	UserName Device name Device serial number Weblet Name Completion Status (Enable / Disable)
99	Network Connectivity Enable / Disable	UserName Device name Device serial number Completion Status (Enable Wireless / Disable Wireless (Enable Wired /Disable Wired)
100	Address Book Permissions	UserName Machine Name Machine serial number Completion Status (SA Only/Open Access Enabled WebUI) / (SA Only/Open Access Enabled LocalUI)
101	Address Book Export	UserName Machine Name Machine serial number
102	SW upgrade enable / disable	UserName Device name Device serial number Completion Status (Enable Installation / Disable Installation)
103	Supplies Plan Activation	Device name Device serial number Completion Status: Success: (if Passcode is ok) Failed: (if Passcode is not ok) Locked out (if Max Attempts Exceed 5) Time Remaining : Hrs (Remaining for next attempt) Min (Remaining for next attempt)
104	Plan Conversion	Device name Device serial number Completion Status: Success: (if Passcode is ok) Failed: (if Passcode is not ok) Locked out (if Max Attempts Exceed 5) Time Remaining : Hrs (Remaining for next attempt) Min (Remaining for next attempt)
105	IPv4 Enable/Disable/Configure	UserName Device name Device serial number Completion Status (Enabled Wireless/Disabled Wireless/ Configured Wireless) (Enabled Wired/Disabled Wired/ Configured Wired)



Event ID	Event description	Entry Data
106	SA PIN Reset	Device serial number Completion Status (Success/Failed)
107	Convenience Authentication Login	UserName Device name Device serial number Completion Status (Success or Failed)
108	Convenience Authentication Enable/Disable/Configure	UserName Device name Device serial number Completion Status (Enabled/Disabled/Configured)
109	Efax Passcode Length	UserName (managing passcodes) Device name Device serial number Completion Status (Passcode Length Changed)
110	Custom Authentication Login	UserName Device name Device serial number Completion Status (Success or Failed)
111	Custom Authentication Enable/Disable/Configure	UserName Device name Device serial number Completion Status (Enabled/Disabled/Configured)
112	Billing Impression Mode	UserName Device name Device serial number Mode Set to (A4 Mode, A3 Mode Completion Status (Success, Failed Impression data



## 4.3. Xerox Standard Accounting

Xerox Standard Accounting (XSA), intended primarily for use as an accounting service, can be used as an internal authorization service. XSA tracks copy, scan (including filing and email), print and fax usage by individual user<sup>1</sup>. The system administrator can enable/disable the feature by service (Copy, Print, Scan, or Fax via the LUI or Web UI, add or delete users, and set usage limits by service for each user. If XSA is enabled, a walk-up user must enter a valid XSA ID before being allowed access to the service for which XSA has been enabled at the device. The device will confirm that the entered XSA ID matches an authorized user, and that the usage limits for the selected service have not been exceeded. In this sense, XSA acts as an authorization service. The system administrator can limit access to device services by setting the usage limits on specific services to zero for users that should not have rights to use the feature. After each job is performed, the user's balance is updated by the number of impressions or scans performed. Services become unavailable to the user when the usage limits are exceeded.

When XSA is enabled in the print driver or on the Web UI or Local UI for print, before a print job is submitted, an XSA ID must also be entered. The ID is sent to the controller for validation. If the submitted ID is valid, the job will print, and the user's balance will be updated by the number of impressions performed. If the submitted ID is invalid, the job is deleted and an error sheet is printed in its place.

The Systems Administrator can chose to track all services (Print, Copy, Scan and Fax) or can choose to permit specific accounting IDs only for color print and color copy.

On demand, the SA will be able to download a report that shows activity for all of the users. The SA can add, modify or remove users and their allocations at any point.

An end user will be able to review their balances by entering a User ID at the Local UI or Web UI.

---

<sup>1</sup> On color machines XSA can track color copy or color print usage.

## 4.4. User Permissions Role Based Access Control (RBAC)

The User Permissions feature has been added to Xerox devices to expand control of access to device services and features which will in turn improve security, enable cost control for media and consumables, and will eliminate unauthorized pages.

User Permissions does as the name suggests and provides permissions based on the authentication of the user either through the Local UI or network authentication. Commonly referred to as Role Based Access Control it assigns each user the permissions to use the MFP based on a default role, a customized role or a Non-Logged-In User role.

The System Administrator can set up 192 Custom Roles to restrict use of color printing, duplex or 2-sided printing, Secure Print, access to certain paper trays, applications that may be used to print, and even times of day that a device may be used. In addition, users can be assigned multiple roles.

Through the Web UI on the Xerox device, the SA may perform the following functions:

- Configure Job Types which will be allowed such as SecurePrint, Normal Print, Sample Set, Delayed Print, Saved Job, and All Others
- Restrict Access to specific Paper Trays
- Restrict Printing times (When Users Can Print)
- Allow or Restrict 1 Sided Printing
- Allow or Restrict Applications from printing to the device. Many applications are shown by default such as Office applications and Browsers. In order to add a new custom application, use your application to send a print job via the Xerox print driver; your application's ID will be added to the Custom Application ID list. Then, Reload the page after sending a print job from the application.

Once configured by the Admin user, and the user has authenticated via network directory services or locally on the device, permissions are granted to features and applications as defined in the Role or Roles assigned to the user.

Detailed procedures for the configuration of Roles can be found in the Systems Administrators Guide in the section entitled **User Permissions**.



## 4.5. SMart eSolutions

SMart eSolutions provides the ability to automatically send data to Xerox to be used for billing (Meter Assistant) and toner replenishment (Supplies Assistant). The Systems Administrator sets up the attributes for the service via the Web UI, including enable/disable participation in SMart eSolutions, and time of day for the daily polling to the Xerox Communication Server. The device can be set to communicate via a proxy server on the customer's network. The proxy server may be set to auto detect proxy settings or to manually set proxy address using the Web UI.

### **Meter Assistant**

Once the connection with the Xerox Communication Server has been established, the Meter Assistant service will poll the Xerox Communication server daily over the network. The server will check whether it is time in the billing cycle to update the meter readings. If so, the server will request reads from the device, and the device will then respond by sending the meter reads back to the server.

### **Supplies Assistant**

Once the connection with the Xerox Communication Server has been established, the Supplies Assistant service will be automatically enabled by request from the Xerox Communication Server. The device will then automatically send supplies data over the network to the Xerox Communication server at a regular interval.

### **Maintenance Assistant**

Once the connection with the Xerox Communication Server has been established, the Maintenance Assistant service will be automatically enabled by request from the Xerox Communication Server. The device will then automatically send device fault codes and log data over the network to the Xerox Communication server at a regular interval.

### **Summary**

The SMart eSolutions communication process means that the device initiates all communication between it and Xerox. Only device ID, device configuration, current firmware versions, meter read and supplies information is transferred. The information is sent encrypted using https (SSL).

## 4.6. Encrypted Partitions

When enabled by the customer at the Web UI, the controller disk is encrypted using the AES algorithm with a 256-bit key. The key is generated dynamically on each boot, and is kept only in volatile memory.

## 4.7. Image Overwrite

The Image Overwrite Security feature provides both Immediate Image Overwrite (IIO) and On-Demand Image Overwrite (ODIO) functions. Immediately before a job is considered complete, IIO will overwrite any temporary files associated with print, network scan, internet fax, network fax, or e-mail jobs that had been created on the controller Hard Disk. The ODIO feature can be executed at any time by the SA and will overwrite the entire document image partitions of the controller Hard disk. Scheduled ODIO may also be configured to run at specific times.

A standard ODIO will overwrite all image data from memory and disks except for Jobs and Folders stored in the Reprint Saved Jobs feature; Jobs stored in the Scan to Mailbox feature (if installed); Fax Dial Directories (if fax card is installed); and Fax Mailbox contents (if fax card is installed). A full ODIO will overwrite all image data from memory and disks as well as the items excluded from a standard ODIO.

### 4.7.1. Algorithm

The overwrite mechanism for both IIO and ODIO conforms to the U.S. Department of Defense Directive 5220.22-M.

The algorithm for the Image Overwrite feature is:

- Step 1: Pattern #1 is written to the sectors containing temporary files (IIO) or to the entire spooling area of the disks (ODIO). (hex value 0x35 (ASCII "5")).
- Step 2: Pattern #2 is written to the sectors containing temporary files (IIO) or to the entire spooling area of the disks (ODIO). (hex value 0xCA (ASCII compliment of 5)).
- Step 3: Pattern #3 is written to the sectors containing temporary files (IIO) or to the entire spooling area of the disks (ODIO). (hex value 0x97 (ASCII "ú")).
- Step 4: 10% of the overwritten area is sampled to ensure Pattern #3 was properly written. The 10% sampling is accomplished by sampling a random 10% of the overwritten area.

### 4.7.2. User Behavior

Once enabled at either the Local UI or Web UI, IIO is invoked automatically immediately prior to the completion of a print, network scan, embedded fax, internet fax, network fax, or e-mail job. If IIO completes successfully, status is displayed in the Job Queue. However, if IIO fails, a popup will appear on the Local UI recommending that the user run ODIO, and a failure sheet will be printed.

ODIO may be invoked either from the Local UI in Tools Pathway or from the CentreWare Internet Services Web UI. Network functions will be delayed until the overwrite is completed. Copying is unavailable while the overwrite itself is underway, but copies may be made while the controller is booting.

Upon completion of the ODIO process, a confirmation sheet which can be turned On or Off by the Administrator is printed in the event of failure. Should this occur, it is recommended that it be re-run.

Please note that invocation of ODIO will cause currently processing print jobs to be aborted. However, scan jobs will not be aborted and so ODIO might fail. The user should insure that all scan jobs have been completed before invoking ODIO. Please refer to the customer documentation for a description on how failures are logged.





### 4.7.3. Overwrite Timing

The ODIO overwrite time is dependent on the type of hard disk in the product. The overwrite times are generally 20 minutes for a Standard ODIO and 60 minutes for a Full ODIO.

IIO is performed as a background operation, with no user-perceivable reduction in copy, print or scan performance.

### 4.7.4. Overwrite Completion Reporting

#### **Immediate Image Overwrite**

When an Immediate Image Overwrite is performed at the completion of each job, the user may view the Completed Jobs Log at the Local UI. In each Job entry there will be an indication if the Job was successfully overwritten or not.

#### **On Demand Image Overwrite**

Upon completion, from the Local UI an entry is made in the Audit Log at the device. This Log may be downloaded by the "admin" user or any user assigned an admin role. The admin may configure whether or not a Confirmation Report will print through the CentreWare Web UI on the Properties tab, under Security. The options are On, Errors Only, and Off.



# Remote Scanning Procedure and Security Issue

ConnectKey Devices contain a remote scan feature.. This feature is for enabling scanning solutions. Remote scan default is 'off' when an MFP ships from the factory. In order to enable remote scanning, the machine administrator will have to enable (change the default) for remote scan.

## To enable the Workflow Scanning Remote Start (TWAIN) feature:

1. Access the ConnectKey MFP using your web browser (insert IP address)
2. Select **Properties** and login.
3. In the Properties tab, select **Services**.
4. In the Services area, select **Workflow Scanning**.
5. In the drop down menu under **Workflow Scanning**, select **Remote Start (TWAIN)**.
6. Select the **On** radio button to enable the **Start Job via Remote Program** option.
7. When remote scan is enabled, a user can initiate a scan from a MFP, a PC or a smart remote device.

**NOTE:** The user needs to be aware that when remote scan is enabled there is a blocking screen from when they put a document in the Document Feeder or on the Document Glass to when they initiate their job, that prohibit a second user could initiate a remote scan. The second user could receive the first user's job. This presents a security issue.

## Multifunction Devices Supporting Remote Scanning (as of this writing)

ColorQube 8700S, 8700X, 8700XF Color MFD  
ColorQube 9301/9302/9303 Color MFD  
WorkCentre 4265 MFD  
WorkCentre 5945/5955 MFD  
WorkCentre 7220/7225 Color MFD  
WorkCentre 7970 Color MFD

ColorQube 8900X Color MFD  
WorkCentre 3655S, 3655X MFD  
WorkCentre 5845/5855/5865/5875/5890 MFD  
WorkCentre 6655 Color MFD  
WorkCentre 7830/7835/7845/7855 Color MFD

## 4.8. FIPS

### 4.8.1. FIPS 140-2 Compliance

You can enable the printer to check its current configuration to ensure that transmitted and stored data is encrypted as specified in FIPS 140-2 (Level 1). Once FIPS 140 mode is enabled, you can allow the printer to use a protocol or feature that uses an encryption algorithm that is not FIPS-compliant, but you must acknowledge this in the validation process. If FIPS mode is enabled, when you enable a non-compliant protocol such as SNMPv3 or NetWare, a message appears to remind you that the protocol uses an encryption algorithm that is not FIPS-compliant. NOTE: If you enable FIPS 140-2 Mode it may not be able to communicate with other network devices that use protocols that do not employ FIPS 140-2 validated algorithms.

When you enable FIPS 140 mode, the printer validates its current configuration by performing the following checks:

- Validates certificates for features where the printer is the server in the client-server relationship. An SSL certificate for HTTPS is an example.
- Validates certificates for features where the printer is the client in the client-server relationship. CA Certificates for LDAP, Xerox Extensible Interface Platform (EIP 2.0), and Smart eSolutions are examples.
- Validates certificates that are installed on the printer, but not used. Certificates for HTTPS, LDAP, or SNMPv3 are examples.
- Checks features and protocols for non-compliant encryption algorithms. For example, NetWare, SNMPv, and SMB use encryption algorithms that are not FIPS-compliant.
- Validates Minimum Certificate Key Length configuration is FIPS compliant (must be 2048 bit).
- Performs CAC, PIV, and .NET card validation.
- Verifies Digital Signing and Encrypted e-mail is FIPS compliant.
- IPSec over IPV6 and IPV4 are FIPS compliant.

When validation is complete, information and links display in a table at the bottom of the FIPS 140-2 configuration page of the webUI.

- Click the appropriate link to disable a non-compliant feature, or protocol.
- Click the appropriate link to replace any non-compliant certificates.
- Click the appropriate link to acknowledge that you allow the printer to use non-compliant features and protocols.



## 4.8.2. Enabling FIPS 140 Mode

1. In CentreWare IS, click Properties > Security > Encryption > FIPS 140-2.
2. Click Enable.
3. Click Run Configuration Check and Apply. A pass or fail message appears. If the configuration check passes, click Reboot Machine to save and restart the printer. If the configuration check fails, the reasons for the failed test are listed in a table with links to disable the protocol, replace the certificate, modify or acknowledge the Certificate Key Length, or allow the printer to use the non-compliant protocol. After non-compliances acknowledged or disabled, re-run the FIPS compliance check and reboot to enable FIPS.

**NOTE: When FIPS 140 Mode is enabled, only FIPS compliant certificates can be installed on the printer.**

## 4.9. Email Signing and Encryption to Self

The device is capable of signing and encrypting emails when the user is authenticated to the device using a CAC, .NET or PIV smart card containing appropriate signing and encryption certificates. The device allows signing to multiple recipients using the SHA256 hash algorithm. The device allows encryption to the authenticated user only, supporting 3DES and AES encryption.

When enabled, the configuration options allow the system administrator the flexibility for the user to choose signing and encryption on a job by job basis, or require one or the other for all jobs.

**NOTE: The crypto algorithms used for smart card authentication, signing and encryption are not FIPS validated in the launch version of software.**

## 4.10. Software Self Test

The Software Self Test features allows an administrator to initiate a test from CentreWare Internet Services (Web UI) to ensure that none of the static files on the device have been altered since they were installed. The Administrator will receive a Pass/Fail response. The test will take into account any Software Upgrades that have been performed. The test is based on a checksum generation of the files.



## 5.1. Responses to Known Vulnerabilities

### 5.1.1. Security @ Xerox ([www.xerox.com/security](http://www.xerox.com/security))

Xerox maintains an evergreen public web page that contains the latest security information pertaining to its products. Please see <http://www.xerox.com/security>

Xerox has created a document which details the Xerox Vulnerability Management and Disclosure Policy used in discovery and remediation of vulnerabilities in Xerox software and hardware. It can be downloaded from this page: <http://www.xerox.com/information-security/information-security-articles-whitepapers/enus.html>

# APPENDICES

## Appendix A – Abbreviations

<b>API</b>	Application Programming Interface
<b>AMR</b>	Automatic Meter Reads
<b>ASIC</b>	Application-Specific Integrated Circuit. This is a custom integrated circuit that is unique to a specific product.
<b>CAT</b>	Customer Administration Tool
<b>CSE</b>	Customer Service Engineer
<b>DADF/DADH</b>	Duplex Automatic Document Feeder/Handler
<b>DHCP</b>	Dynamic Host Configuration Protocol
<b>DNS</b>	Domain Name Server. A centralized database that maps host names to static IP addresses.
<b>DDNS</b>	Dynamic Domain Name Server. Maps host names to dynamic static IP addresses.
<b>DRAM</b>	Dynamic Random Access Memory
<b>EEPROM</b>	Electrically erasable programmable read only memory
<b>EGP</b>	Exterior Gateway Protocol
<b>GB</b>	Gigabyte
<b>HP</b>	Hewlett-Packard
<b>HTTP</b>	Hypertext transfer protocol
<b>IBM</b>	International Business Machines
<b>ICMP</b>	Internet Control Message Protocol
<b>IETF</b>	Internet Engineering Task Force
<b>IFAX</b>	Internet Fax
<b>IIO</b>	Immediate Image Overwrite
<b>IIT</b>	Image Input Terminal (the scanner)
<b>IT</b>	Information Technology
<b>IOT</b>	Image Output Terminal (the marking engine)
<b>IP</b>	Internet Protocol
<b>IPSec</b>	Internet Protocol Security
<b>IPX</b>	Internet Protocol Exchange
<b>LAN</b>	Local Area Network
<b>LDAP</b>	Lightweight Directory Access Protocol
<b>LDAP Server</b>	Lightweight Directory Access Protocol Server. Typically the same server that is used for email. It contains information about users such as name, phone number, and email address. It can also include a users login alias.
<b>LED</b>	Light Emitting Diode
<b>LPR</b>	Line Printer Request
<b>MAC</b>	Media Access Control
<b>MIB</b>	Management Information Base
<b>n/a</b>	not applicable
<b>NDPS</b>	Novell Distributed Print Services
<b>NETBEUI</b>	NETBIOS Extended User Interface
<b>NETBIOS</b>	Network Basic Input/Output System
<b>NOS</b>	Network Operating System
<b>NVRAM</b>	Non-Volatile Random Access Memory
<b>NVM</b>	Non-Volatile Memory



<b>ODIO</b>	On-Demand Image Overwrite
<b>PCL</b>	Printer Control Language
<b>PDL</b>	Page Description Language
<b>PIN</b>	Personal Identification Number
<b>PWBA</b>	Printed Wire Board Assembly
<b>PWS</b>	Common alternative for PSW
<b>RFC</b>	Required Functional Capability
<b>SA</b>	System Administrator
<b>SFTP</b>	Secure File Transfer Protocol
<b>SLP</b>	Service Location Protocol
<b>SNMP</b>	Simple Network Management Protocol
<b>SRAM</b>	Static Random Access Memory
<b>SSDP</b>	Simple Service Discovery Protocol
<b>SSL</b>	Secure Sockets Layer
<b>TCP</b>	Transmission Control Protocol
<b>TIFF</b>	Tagged Image File Format
<b>UI</b>	User Interface
<b>URL</b>	Uniform Resource Locator
<b>UDP</b>	User Datagram Protocol
<b>WebUI</b>	Web User Interface – the web pages resident in the WorkCentre Pro. These are accessible through any browser using the machine's IP address as the URL.
<b>XCMi</b>	Xerox Common Management Interface
<b>XSA</b>	Xerox Standard Accounting

## Appendix B – Supported MIB Objects

### NOTES:

- (1) The number of objects shown per MIB group represents the number of objects defined by the IETF standard for that MIB group. It does not represent the instantiation of the MIB group which may contain many more objects.
- (2) Some MIB objects defined within Input and Output groups of the Printer MIB (*RFC 1759*) have a MAX-ACCESS of RW. However, the Printer MIBv2 defines a MIB-ACCESS of RO for these MIB objects within the Input and Output groups and all machines assessed support RO access. Therefore, RO access to these MIB objects is considered IETF compliant.
- (3) It is assumed that mandatory IETF string-related MIB objects shall contain meaningful data; not blank strings
- (4) The "(C)" notation indicates that the previously stated item is a true caveat condition. The "(I)" notation indicates that the previous stated item should be regarded as information only.
- (5) MIB objects that CANNOT be populated with meaningful data (e.g. a machine may not have paper level sensors, hence, can only support "0" or "-3 for more than 1 sheet" for prtInputCurrentLevel) will be considered a caveat, denoted as "(C)".
- (6) The Printer MIB requires a few groups from RFC 1213 and RFC 1514 to be supported. Therefore, this assessment will indicate that these groups are "supported" as long as the basic MIB structures have been implemented.

### Support Definitions

Term	Definition
"supported"	all MIB objects exists and are populated w/ meaningful data that is consistent w/ the hardware installed within the machine.
"supported w/ caveats"	all MIB objects exists, however, 2 major bugs or less may exists w/ some of the objects that were not fixed
"not supported"	MIB objects do not exist/implementation was not planned
"not fully supported"	MIB objects exists, HOWEVER, are NOT populated w/ meaningful data OR provide only default values OR contain 3 or more major bugs
"optional, **"	optional group that is NOT required by the RFC, however, an implementation may exist; some MIB objects may not be populated w/ meaningful data

SNMP version / Network Transport support	WorkCentre
SNMPv1 (RFC 1157)	supported
SNMPv2P (RFCs 140x)	not supported
SNMPv2C (RFCs 190x)	supported
SNMPv3 (RFCs 1902, 2572, 2574)	supported
SNMP over UDP (IP)	supported
SNMP over IPX (Netware)	supported
SNMP over NETBEUI (Microsoft Networking)	not supported (implemented but never delivered)





RFC 3805 - Printer MIB Group	WorkCentre
RFC 1213 - System group	supported
RFC 1213 - Interface group	supported
RFC 1514 - Storage group	supported
RFC 1514 - Device group	supported
General group [7 objects]	supported
Covers group [3 objects]	supported
Localization group [4 objects]	supported w/ caveats = only US English language supported
Responsible Party group [2 objects] - OPTIONAL	supported
System Resources group [4 objects]	supported
Input group [12 objects]	supported
Extended Input group [7 objects] - OPTIONAL	supported
Input Media group [4 objects] - OPTIONAL	supported
Output group [6 objects]	supported w/ caveats = only "-3" (i.e. can accept 1 or more sheets) can be supported for the Top Tray (C)
Extended Output group [7 objects] - OPTIONAL	supported
Output Dimensions group [5 objects] OPTIONAL	supported
Output Features group [6 objects] - OPTIONAL	supported
Marker group [15 objects]	supported
Marker Supplies group [9 objects] - OPTIONAL	supported
Marker Colorant group [5 objects] - OPTIONAL	supported
Media Path group [11 objects]	supported
Channels group [8 objects]	supported
Interpreter group [12 objects]	supported
Console group [4 objects]	supported w/ caveats = prtConsoleDisable is hardcoded to enabled(3), prtConsoleLocalization hardcoded to 1
Console Display Buffer group [2 objects]	supported w/ caveats = limited local UI messaging captured within table (C), local UI button selection messages are not captured within table
Console Display Light group [5 objects]	supported w/ caveats = only the Power Saver LED is supported, the other LEDs were not implemented because they represent local UI menu activations (I)
Alert Table group [8 objects]	supported
Alert Time group [1 object] - OPTIONAL	supported

RFC 2790 – Host Resources MIB group	WorkCentre
System group [7 objects]	supported
Storage group [8 objects]	supported
Devices group [6 objects]	supported
Processor Table [2 objects]	supported
Network Interface Table [1 object]	supported
Printer Table [2 objects]	supported
Disk Storage Table [4 objects]	supported
Partition Table [5 objects]	supported
File System Table [9 objects]	supported
Software Running group [7 objects] – OPTIONAL	optional, not supported
Software Running Performance group [2 objects] – OPTIONAL	optional, not supported
Software Installed group [7 objects] – OPTIONAL	optional, not supported

RFC 1213 - MIB-II for TCP/IP group	WorkCentre
System group [7 objects]	supported
Interfaces group [23 objects]	supported w/ caveats = ifInUnknownProtos does not work
Address Translation group [3 objects]	supported, but this group has been DEPRICATED by the IETF
IP group [42 objects]	supported
ICMP group [26 objects]	supported
TCP group [19 objects]	supported
UDP group [6 objects]	supported
EGP group [20 objects]	not applicable because Exterior Gateway Protocol not supported by machine
Transmission group [0 objects]	not applicable because the group has not yet been defined by the IETF
SNMP group [28 objects]	supported
System Object Resources Table/objects per RFC 1907 [8 objects]	supported

Additional Capabilities / Application Support	WorkCentre
ability to change GET, SET, TRAP PDU community names	supported, default values : GET="public", SET="private", TRAP="SNMP_trap"
Printer MIB traps	supported = printerV1Alert, printerV2Alert
SNMP Generic Traps	supported = coldStart, warmStart, authenticationFailure
Vendor-specific Traps	supported = xcmJobV1AlertNew, xcmJobV2AlertNew for job monitoring alerts
set trap destination address(es) for any 3rd party Net Mgmt apps.	supported via Web UI
polling for IETF status objects using any 3rd party Net Mgmt apps.	supported
walking IETF MIB tree structure using any 3rd party Net Mgmt app. (e.g. HP OpenView, etc.) / shareware program	supported
New type 2 enumerations from next generation Host Resources MIB supported	optional, not support because Host Resources MIBv2 has NOT entered the standards track
New type 2 enumerations from next generation Printer MIB supported	supported
New Printer MIBv2 objects implemented	optional, not support because Printer MIBv2 has NOT entered the standards track
IETF AppleTalk MIB (RFC ?) implemented	not supported
Job monitoring via MIBs	supported via Xerox MIBs
Vendor-specific MIBs implemented	supported = Network Connectivity, Job Monitoring, Scan-to-File, and Scan-to-LAN FAX features supported via Xerox MIBs
Vendor-specific MIBs provided to customer	supported w/ caveat = planned support within 2 - 3Q00 via Xerox web site, URL = www.xerox.com
Vendor-specific client application(s) provided	CentreWare Services
required Windows2000 MIB objects supported	supported
Embedded Web Server support	supported
Xerox PrinterMap application support	supported
Xerox PrintXchange support	supported
Novell Distributed Print Services support	supported = w/ Xerox NDPS Gateway solution w/ improved device status
Dazel Output Management Environment	supported
HP OpenView snap-in module	supported
CA Unicenter snap-in module	supported
IBM/Tivoli NetView snap-in module	supported

## Appendix C – Standards

### Controller Hardware

PCI Specification (PCI Local Bus Specification Revision 2.1)  
 100 Megabit Ethernet (IEEE 802.3)  
 Universal Serial Bus 1.1  
 Parallel (IEEE 1284)  
 IEEE 1394a (FireWire)

### Controller Software

Function	RFC/Standard
Internet Protocol	950
Internet standard subnetting procedure	919
Broadcasting internet datagrams	922
IP Version 6	2460
IP Version 6 Addressing Architecture	2373
ICMP Version 6 Protocol	2463
Transition Mechanisms for IPv6 Hosts and Routers	1933
Transmission Control Protocol (TCP)	793
User Datagram Protocol	768
Standard for the transmission of IP datagrams over Ethernet networks	894
Standard for the transmission of IP datagrams over IEEE802 networks	1042
ICMP – ICMP Echo, ICMP Time, ICMP Echo Reply, and ICMP Destination Unreachable message.	792
Reverse Address Resolution Protocol (RARP)	903
Bootstrap Protocol (BOOTP)	951
Clarifications and Extensions for the Bootstrap Protocol (BOOTP)	1542
X.500 Distinguished Name RFC references	1779, 2253, 2297, 2293
SLP	2608
Dynamic Host Configuration Protocol (DHCP)	2131
DHCP Options and BOOTP Vendor Extensions	2132
X.509 Certificate RFC references	2247, 2293, 2459, 2510, 2511, 3280
Hyper Text Transfer Protocol version 1.1 (HTTP)	2616
Line Printer Daemon (LPR/LPD)	1179
File Transfer Protocol (FTP)	959
SNMPv1	1157
SNMPv2	1901, 1905, 1906, 1908, 1909
SNMPv3	1902, 2572, 2574
Structure of Management Information (SMI) for SNMPv1	1155, 1212
Structure of Management Information (SMI) for SNMPv2	1902, 1903, 1904
IETF MIBs: MIB II	1213
Host Resources	2790
RFC 3805 (Printer), Printer MIB V2	3805
SNMP Traps	1215
Document Printing Application (DPA)	10175
Appletalk	Inside Appletalk, Second Edition



## **Printing Description Languages**

Postscript Language Reference, Third Edition

PCL6 (PCL5C + PCL XL class 3.0 emulation)

TIFF 6.0

JPEG

Portable Document Format Reference Manual Version 1.3

## Appendix E – References

Kerberos FAQ <http://www.cmf.nrl.navy.mil/krb/kerberos-faq.html>

IP port numbers <http://www.iana.org/assignments/service-names-port-numbers/service-names-port-numbers.xml>